



勃凌科技(香港)有限公司
 地址: 中国香港湾仔谢斐道218号谢斐大楼5楼218C
 电话: 400 077 3898

东莞市勃凌塑胶制品有限公司
 地址: 中国广东省东莞市黄江镇板湖工业区
 电话: 0769-83361805 83607655 83685688
 传真: 0769-83664689
 网址: <http://www.gdbl.net> <http://www.cabletedbl.com>
 邮箱: blstjpc@163.com boling@gdbl.net

Boling Technology (Hong Kong) Co., Ltd.
 Address: 5th Floor, 218C 218 Jaffe Road, Wanchai, China Hong Kong Jaffe Building
 Tel: 4000773898

Dongguan Boling Plastic Products Co., Ltd.
 Add: Banhu Industrial Park, Huangjiang Town, China Dongguan City, Guangdong Province
 Tel: 0769-83361805 83607655 83685688
 Fax: 0769-83664689
 Website: <http://www.gdbl.net> <http://www.cabletedbl.com>
 E-mail: blstjpc@163.com boling@gdbl.net

全国免费服务电话: 400 077 3898
 National Free Service Tel: 400-077-3898



扫描官网, 了解更多

BOLING

WIRING ACCESSORIES

综合目录 No.15

地址: 中国广东省东莞市黄江镇板湖工业区



GENERAL CATALOG

勃凌塑胶·综合目录 No.15

NYLON CABLE TIES • R-TYPE CLAMP • AUTOMATIC TIE MACHINE
 尼龙扎带 • R型线夹 • 自动扎带机



Company profile

公司概况

东莞市勃凌塑胶制品有限公司：创建于2000年初，是国内最大配线器材生产企业之一，公司先后通过ISO9001国际质量体系认证、ISO14001环境管理体系认证，产品已通过美国UL认证、欧共体CE标准化。

公司占地面积8000平方米，被评为“花园式”厂区，专业生产：尼龙扎带、R型线夹、梯形扎带、不锈钢扎带、封条扎带、闭端子、接线端子、压线帽、LED接隔柱，并自主研发：自动尼龙扎带机。产品畅销全国各地及东南亚、欧洲、美洲、港澳台地区并与国内一些大型知名企业建立长期配套合作。

“诚实、务实、创新、感恩”是我们企业的精神，立足中国，放眼世界，做优秀的知名企业，以热情、快速、高品质的贴心服务。竭诚欢迎各界人士光临指导，携手合作，共谋发展。

Dongguan Boling Plastic Products Co., Ltd., Founded in early 2000, is one of the largest distribution equipment manufacturer, the company has passed ISO9001 international quality system certification, ISO14001 environmental management system certification, the products have passed UL certification, the European Community CE standardization body.

The company covers an area of 8000 square meters, was named the "garden-style" factory, specializing in the production: nylon cable ties, R-type clamp, trapezoidal tie, stainless steel cable ties, cable ties seals, closed terminal, terminal blocks, wire connectors, LED connected across the column, and independent research: Automatic machine nylon cable ties. Products sold throughout the country and Southeast Asia, Europe, America, Hong Kong, Macao and Taiwan regions and some large well-known domestic enterprises to establish long-term support and cooperation.

"Honest, pragmatic, innovative, Thanksgiving" is the spirit of enterprise, based in China, the world famous enterprises do good, warm, fast, high-quality personalized service. We sincerely welcome people to visit, work together to seek common development.





Accumulate Ten sharp change

厚积薄发，十年锐变

经营理念

厚德务实 创新发展 永续经营 优质服务

质量方针

合理成本 持续改善 顾客满意

经营政策

为员工谋利益 为社会创价值

核心精神

诚信 创新 感恩 责任

Business Philosophy

Virtuous and Pragmatic, Innovative Development, Sustainable Business, High-quality Service

Quality Policy

Reasonable Cost, Sustainable Improvement, Customer Satisfaction

Business Policy

Seek for Interests for Staff, Create Value for Society

Core Spirit

Credible, Innovative, Grateful, Responsible



Corporate values

企业文化

塑造人的品质，建立管理根基
 技术是基础，管理是动力
 讲究实效、完善管理、提升品质、增创效益

Shaping people's quality management foundation established
 Technology is the basis, the management is the driving force
 Stress practical results, improve management, improve quality, create efficiency



The Team

团队

东莞市勃凌塑胶制品有限公司以人为本、人尽其才、才尽其用，以提高员工最好的状态和工作热情度，使之成为团结奋进的优异团体！科学钻研的管理团队是勃凌的关键核心；勇于开拓、锐意进取的销售团队是勃凌的动力源泉；勤奋踏实的生产团队是勃凌的发展基石；严谨细致的质检团队是勃凌的品质后盾。

Dongguan Boling plastic products co., LTD., people-oriented, men use, in order to improve the best from staff and workers
 Passion, make it become the unity of the excellent group! Scientific study of the core management team is the key to Boling;
 Have the courage to explore and forge ahead of the sales team is comprised of Boling power source; Assiduous sureness of the production team is the development foundation of Boling;
 Rigorous and meticulous qc team is Boling quality backing.

Perfect production system

完美的生产体系

生产核心

品质/交期/效率/整顿/安全

严谨做事，专注细节，追求完美品质
每一个工作人员都经过严格的岗前培训，合格后方可上岗

高效快速的供应链、完善的生产控制流程、先进的生产设备、严格的作业标准、高素质的员工队伍是我们服务客户的保障

Core Production

Quality / delivery / efficiency / consolidation / Security

Rigorous work, attention to detail, the pursuit of perfect quality
Each staff member has to undergo a rigorous pre-service training, qualified before the appointment

Rapid and efficient supply chain, improve production control processes, advanced production equipment, strict operating standard
Accurate, high-quality workforce is our customer service protection





Strict quality control system

严谨的品质控制体系

严谨的工作，打造“完美品质”

严谨的设计品质，严格的过程控制，打造客户满意的产品；
对“零缺陷”的持续追求，打造“完美品质”

Rigorous work attitude create the "perfect quality"

Rigorous design quality, strict process controlling, manufacture customer satisfaction products;
Continous pursuing "zero defect" to create perfect quality





Strict quality management, pursuit perfect quality

严格的质量管理，追求“完美品质”

质量方针

严格标准，坚守原则；主动预防，持续改善

Quality policy

Strict standards, adhere to the principle; active prevention, continuous improvement



Qualification Certificate

资质证书

ISO9001 ISO14001 REACH



Radiation country and the world

辐射全国，放眼世界

“诚招天下客，誉从质中来”。长期以来，勃凌十分注重与客户的友好合作，保证品质与服务，珍视荣誉，从而赢得了客户的信赖与支持。与朋友广泛合作，共享繁荣，也成为我们最正城的追求。

"Recruitment world passenger and reputation from the stroma." For a long time, boling great attention to friendly cooperation with customers to ensure the quality and services, the value of honor, to win the customer's trust and support. Extensive cooperation with friends and shared prosperity, the city has become our most positive pursuit.



- | | | | | |
|----------------|----------------------|----------------|------------------|------------------|
| 1. ALGERIA | 19. CROATIA | 37. IRAN | 55. MOROCCO | 73. SOUTH AFRICA |
| 2. ARGENTINA | 20. CZECH | 38. IRELAND | 56. NEW ZEALAND | 74. SPAIN |
| 3. AUSTRALIA | 21. DENMARK | 39. ISRAEL | 57. NEPAL | 75. SRI LANKA |
| 4. AUSTRIA | 22. DOMINICA | 40. ITALY | 58. NIGERIA | 76. SWEDEN |
| 5. AZERBAIJAN | 23. EGYPT | 41. JAPAN | 59. NORWAY | 77. SWITZERLAND |
| 6. BAHRAIN | 24. FINLAND | 42. JORDAN | 60. OMAN | 78. SYRIA |
| 7. BANGLADESH | 25. FRANCE | 43. KAZAKHSTAN | 61. PANAMA | 79. TAIWAN |
| 8. BRAZIL | 26. GERMANY | 44. KENYA | 62. PAKISTAN | 80. THAILAND |
| 9. BELARUS | 27. GREECE | 45. KOREA | 63. PARAGUAY | 81. TURKEY |
| 10. BELGIUM | 28. GHANA | 46. KUWAIT | 64. PERU | 82. TUNIS |
| 11. BOLIVIA | 29. HAWAIIAN ISLANDS | 47. LATVIA | 65. PHILIPPINE | 83. U.K |
| 12. BULGARIA | 30. HOLLAND | 48. LEBANON | 66. POLAND | 84. U.S.A |
| 13. COSTA RICA | 31. HONDURAS | 49. LITHUANIA | 67. PORTUGAL | 85. URUGUAY |
| 14. CUBA | 32. HONG KONG | 50. MACAU | 68. ROMANIA | 86. UKRAINE |
| 15. CYPRUS | 33. HUNGARY | 51. MALAYSIA | 69. RUSSIA | 87. U.A.E |
| 16. CANADA | 34. ICELAND | 52. MALTA | 70. SAUDI ARABIA | 88. UZBEKISTAN |
| 17. CHILE | 35. INDIA | 53. MAURITIUS | 71. SLOVAKIA | 89. VENEZUELA |
| 18. COLOMBIA | 36. INDONESIA | 54. MEXICO | 72. SINGAPORE | 90. VIETNAM |
| | | | | 91. YEMEN |

Purchase Notice 购买须知

我们保证我公司在售期间不存在原料上的品质问题，但我们这项承诺下的义务也是有限的，既任何关于退换货的要求必须自发货之日起六个月内提出，经证明确属厂家责任，并不包括诸如运费，税费等在内的索赔要求，我们均可接受。

使用者可自主决定合适的产品用于其特定的用途，并自行承担随之产生的相关的所有风险和责任，销售商和制造商对其由于不当使用而产生的任何直接或间接的伤害、损失、损害概不负责！

Our products are warranted to be free from defects in materials at the time of sale but our obligation under this warranty is limited to the replacement of any product proved to be defective within 6 months from the date of delivery and can prove to be the responsibility of factory. No further claim, such as freight, tax...etc. Will be accepted.

User shall determine the suitability what soever in connection therewith. Neither seller nor manufacturer shall be liable for any injury, loss or damage, whether direct or consequential, arising out of the use of, or the inability to use, the product.

INDEX 索引

02 自锁式尼龙扎带
Self-locking Nylon Cable Ties



06 绿色高温扎带
High Temperature Cable Ties



06 乳白色高温扎带
Milky High Temperature Cable Ties



08 可松式尼龙扎带
Releasable Cable Ties



08 标牌式尼龙扎带
Marker Nylon Cable Ties

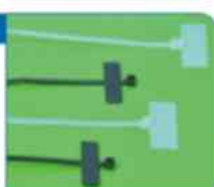

09 插槽式尼龙扎带
Push Mount Ties



09 固定头式尼龙扎带
Mountable Head Ties



10 反穿式尼龙扎带
Anti-Wear Nylon Cable Ties

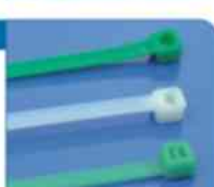

10 平头式尼龙扎带
Flat nylon cable ties



10 珠形字母扣
Mother Of Pearl-Shaped Buckle



11 双扣珠孔线带
Twill Micropyle Line Bag



11 珠孔形尼龙扎带
Knot Ties



13 组合性束带
Diy Package Cable Tie



15 桶装组合
Barrel Combination



17 不锈钢扎带(船用)
Stainless Steel Cable Ties For On Board Ships&Offshore Units



19 R型线夹组合装
R Type Clamp Combination



20 鱼骨束线带
Fusg Bibe Shape Head Ties



20 梯形束线带
Trapezoidal beam Line With



20 卷式结束保护带
(螺旋管)
Spiral Wrapping Bands



21 扁型钢钉线卡
Flat Cable Clips



21 塑料安全条
Plastic Security Seals

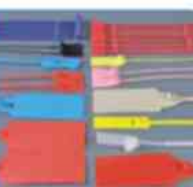

22 尼龙电缆固定头
Cable Glands



24 闭端子
Closed Terminal



24 螺旋式压线帽
All Plastics Connectors



24 接线端子
Terminal Blocks



25 电源线扣
Power line deduction



25 尼龙软管
Nylon Flexible Conduit



27 扎线固定座
Wire Clip



27 扣束线座
Button Harness Seat



28 配线固定座
Wiring Fixing Seat



28 粘贴式扣环
Cable Clip



29 可调式电线固定座
Adjustable Cable Clamp



29 可调式固定座
Adjustable Cable Clamp



30 插槽式固定座
Push Tie Mount



30 超薄LED间隔柱
Super Bo LED Spacers



30 方孔LED间隔柱
Square Hole LED Spacers



31 圆孔LED间隔柱
Round Hole LED Spacers



31 圆孔双坑LED间隔柱
The Hole Double Pit LED Spacers



31 PC板固定座
PC Board Holder



32 PC板间隔柱
PC Board Spacers



32 月牙间隔柱
Crescent Spacers



33 十字盘头螺丝
Phillips Pan Head Screws



33 十字沉头螺丝
Phillips Head Screws



34 外六角螺丝
Hexagon Screws



34 公制塑胶螺母
Metric Plastic Nut



35 热收缩套管
Heat Shrinkable Tubings



36 铁氟龙套管
Teflon Tube



37 硅橡胶玻璃纤维套管
Silicone Rubber Glassfiber Sleeving



38 挤出型内纤外胶
Extrusion type fiber inside and rubber outside



39 玻璃纤维硅橡胶
(内胶外纤)套管
Glassfiber Silicone Rubber Sleeving (inside is silicone rubber and outside is glassfiber)



40 BL-001



40 BL-600A



40 BL-500



41 全自动尼龙扎带机
Automatic Nylon Strapping Machine



一言九鼎



**INTEGRITY OF THE WORLD
KEPT THEIR PROMISES
INTEGRITY IS GOLDEN**

诚信天下

一言九鼎，诚信是金；诚实是人生的命脉，是一切价值的根基；诚信是一种心灵的开放；以诚为人，至信为业。



Living on quality, Developing on credit!
信誉求发展，质量求生存!

Cable Ties



自锁式尼龙扎带

- ◆ 材质: 采用UL认可之尼龙66料制成, 防火等级94V-2, 耐酸、耐蚀、绝缘性良好, 不易老化、承受力强。
- ◆ 操作温度: -35℃ to 85℃。
- ◆ 颜色: 标准颜色为白色(白色), 另有抗紫外线之黑色, 特殊颜色欢迎订做。

Self-locking Nylon Cable Ties

- ◆ Material: Nylon 66, 94V-2 certified by UL. Heat-resisting, Acid & erosion control, insulate well and not apt to age.
- ◆ Operating temperature: -35℃ to 85℃.
- ◆ Color: Natural (or white, standard color), UV black and other colors are available as requested.

W=white & natural(白色)

BR=Brown(棕色)

OR=Orange(橘色)

GN=Green(绿色)

PP=Purple(紫色)

B=Black(黑色)

RD=Red(红色)

YL=Yellow(黄色)

BL=Blue(蓝色)

GY=Gray(灰色)

规格 ITEM.NO.	L(长)		W(宽) (mm)	捆扎范围 BUNDLE DIAMETER E(mm)	拉力	
	LNCH	(mm)			MIN. LOOP LBS	TENSILE STRENGTH KGS
BL-3x60	2 3/8	60	2.5	2-11	18	8
BL-3x80	3 3/8	80	2.5	2-16	18	8
BL-3x100	4	100	2.5	2-22	18	8
BL-3x120	4 3/4	120	2.5	2-30	18	8
BL-3x140	5 1/2	140	2.5	2-33	18	8
BL-3x150	6	150	2.5	2-35	18	8
BL-3x160	6 1/4	160	2.5	2-40	18	8
BL-3x200	8	200	2.5	3-50	18	8
BL-3x250	10	250	2.5	3-65	18	8
BL-4x100	4	100	3.6	3-22	40	18
BL-4x120	4 3/4	120	3.6	3-30	40	18
BL-4x150	6	150	3.6	3-35	40	18
BL-4x180	7	180	3.6	3-42	40	18
BL-4x200	8	200	3.6	3-50	40	18
BL-4x250	10	250	3.6	3-65	40	18
BL-4x300	11 5/8	300	3.6	3-80	40	18
BL-4x350	13 3/4	350	3.6	3-90	40	18
BL-4x370	14 1/2	370	3.6	3-102	40	18
BL-4x400	15 3/4	400	3.6	3-105	40	18
BL-5x100	4	100	4.8	3-22	50	22
BL-5x120	4 3/4	120	4.8	3-30	50	22
BL-5x150	6	150	4.8	3-35	50	22
BL-5x200	8	200	4.8	3-50	50	22
BL-5x250	10	250	4.8	3-65	50	22
BL-5x300	11 5/8	300	4.8	3-82	50	22
BL-5x350	13 3/4	350	4.8	3-90	50	22
BL-5x380	14 1/4	370	4.8	3-102	50	22
BL-5x400	15 3/4	400	4.8	3-105	50	22
BL-5x430	17	430	4.8	3-110	50	22
BL-5x450	17 3/4	450	4.8	3-130	50	22
BL-5x500	19 11/16	500	4.8	3-150	50	22
BL-5x550	21 1/16	550	4.8	3-33	50	22
BL-5x600	23 5/8	600	4.8	3-170	50	22
BL-5x650	25 9/16	650	4.8	3-190	50	22

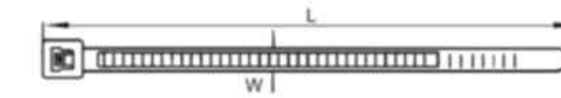

规格 ITEM.NO.	L(长)		W(宽) (mm)	捆扎范围 BUNDLE DIAMETER E(mm)	拉力	
	LNCH	(mm)			MIN. LOOP LBS	TENSILE STRENGTH KGS
BL-8x150	6	150	7.6	3-33	120	55
BL-8x200	8	200	7.6	3-50	120	55
BL-8x250	10	250	7.6	4-63	120	55
BL-8x300	11 5/8	300	7.6	4-82	120	55
BL-8x350	13 3/4	350	7.6	4-90	120	55
BL-8x370	14 1/4	370	7.6	4-98	120	55
BL-8x400	15 3/4	400	7.6	4-105	120	55
BL-8x450	17 3/4	450	7.6	4-118	120	55
BL-8x500	19 11/16	500	7.6	4-150	120	55
BL-8x550	21 1/16	550	7.6	4-160	120	55
BL-8x600	23 5/8	600	7.6	4-170	120	55
BL-450	17 3/4	450	9.0	4-118	175	80
BL-500	19 11/16	500	9.0	4-150	175	80
BL-530	20 3/4	530	9.0	8-155	175	80
BL-550	21 1/16	550	9.0	8-160	175	80
BL-600	23 5/8	600	9.0	8-170	175	80
BL-650	25 9/16	650	9.0	8-190	175	80
BL-700	27 1/2	700	9.0	10-205	175	80
BL-920	36 1/4	920	9.0	10-265	175	80
BL-1020	40 1/8	1020	9.0	10-295	175	80
BL-1220	48	1220	9.0	10-340	175	80
BL-450	17 3/4	450	10.0	10-125	200	91
BL-500	19 11/16	500	10.0	12-150	200	91
BL-300	11 5/8	300	12.7	12-82	250	114
BL-400	15 3/4	400	12.7	12-105	250	114
BL-540	21 1/4	540	12.7	14-155	250	114
BL-650	25 9/16	650	12.0	14-190	250	114
BL-750	29 9/16	750	12.0	10-220	250	114
BL-780	30 3/4	780	12.7	14-230	250	114

DBL 勃凌

Cable Ties



规格 ITEM.NO.	L(长) LNCH	(mm)	W(宽) (mm)	捆扎范围 BUNDLE DIAMETER E(mm)	拉力 MIN.LOOP TENSILE STRENGTH LBS	拉力 KGS
BL-1.8x80	3 3/8	60	1.8	2-16	14	6.5
BL-1.8x100	4	100	1.8	2-22	14	6.5
BL-2.0x100	4	100	2.0	2-22	14	6.5
BL-2.3x100	4	100	2.3	2-22	14	6.5
BL-2.0x120	4 3/4	120	2.0	2-30	14	6.5
BL-2.0x150	6	150	2.0	2-35	14	6.5
BL-2.0x200	8	200	2.0	3-35	14	6.5
BL-2.7x200	8	200	2.7	3-35	18	8
BL-2.8x200	8	200	2.8	3-35	32	15
BL-2.8x250	10	250	2.8	3-65	33	15
BL-2.5x250	10	250	2.5	3-65	33	15
BL-2.8x300	11 3/8	300	2.8	3-80	33	15
BL-5.0x200	8	200	5.0	3-35	65	22
BL-5.0x250	10	250	5.0	3-65	65	22
BL-5.0x300	11 3/8	300	5.0	3-80	65	22
BL-5.0x400	15 3/4	400	5.0	3-105	65	22
BL-5.0x450	17 3/4	450	5.0	4-130	65	22
BL-6.0x300	11 3/8	300	6.0	3-80	65	30
BL-6.0x350	13 3/4	350	6.0	3-90	65	30
BL-6.0x380	15	380	6.0	3-102	65	30
BL-6.0x400	15 3/4	400	6.0	3-105	65	30
BL-6.0x450	17 3/4	450	6.0	4-130	65	30
BL-7.0x400	15 3/4	400	7.0	4-105	85	38
BL-7.0x450	17 3/4	450	7.0	4-130	85	38



Living on quality, Developing on credit!
信誉求发展, 质量求生存!

Cable Ties



绿色高温扎带

- ◆ 材质：采用UL认可之尼龙66制成，防火等级94V-2，耐酸、耐碱、绝缘性良好，不易老化、承受力强。
- ◆ 操作温度：120℃ to 180℃。
- ◆ 颜色：标准颜色为白色（绿色），另有抗紫外线之黑色，特殊颜色欢迎订做。

High Temperature Cable Ties

- ◆ Material: Nylon 66,94V-2 certified by UL. Heat-resisting, Acid & erosion contro,insulate well and not apt to age.
- ◆ Operating temperature:120℃ to 180℃.
- ◆ Color: Natural(or white,standard color),UV black and other colors are available as requested.

◆ 绿色高温扎带 Green High Temperature Cable Ties

规格 ITEM.NO.	L(长) LNCH	W(宽) (mm)	捆扎范围 BUNDLE DIAMETER E(mm)	温度 TEMPERATURE ℃	拉力 MIN LOOP TENSILE STRENGTH LBS	拉力 KGFS	
BL-2.5x80	3 3/16	80	2.5	2-16	120	18	8
BL-2.5x100	4	100	2.5	2-22	120	18	8
BL-2.5x120	4 3/4	120	2.5	2-30	120	18	8
BL-2.5x150	6	150	2.5	2-35	120	18	8
BL-2.5x200	8	200	2.5	3-50	120	18	8
BL-2.5x250	10	250	2.5	3-65	120	18	8
BL-3.6x150	6	150	3.6	3-35	120	40	18
BL-3.6x200	8	200	3.6	3-50	120	40	18
BL-3.6x250	10	250	3.6	3-65	120	40	18
BL-3.6x300	11 5/8	300	3.6	3-80	120	40	18
BL-4.8x150	6	150	4.8	3-35	120	50	22
BL-4.8x200	8	200	4.8	3-65	120	50	22



◆ 乳白色高温扎带 Milky High Temperature Cable Ties

规格 ITEM.NO.	L(长) LNCH	W(宽) (mm)	捆扎范围 BUNDLE DIAMETER E(mm)	温度 TEMPERATURE ℃	拉力 MIN LOOP TENSILE STRENGTH LBS	拉力 KGFS	
BL-2.5x80	3 3/16	80	2.5	2-16	180	18	8
BL-2.5x100	4	100	2.5	2-22	180	18	8
BL-2.5x120	4 3/4	120	2.5	2-30	180	18	8
BL-2.5x150	6	150	2.5	2-35	180	18	8
BL-2.5x200	8	200	2.5	3-50	180	18	8
BL-3.6x100	4	100	3.6	3-22	180	40	18
BL-3.6x120	4 3/4	120	3.6	3-30	180	40	18
BL-3.6x150	6	150	3.6	3-35	180	40	18
BL-3.6x200	8	200	3.6	3-50	180	40	18
BL-3.6x250	10	250	3.6	3-65	180	40	18
BL-3.6x300	11 5/8	300	3.6	3-80	180	40	18
BL-4.8x150	6	150	4.8	3-35	180	50	22
BL-4.8x200	8	200	4.8	3-65	180	50	22



Living on quality, Developing on credit!
信誉求发展, 质量求生存!

Cable Ties



可松式尼龙扎带 Releasable Cable Ties

- ◆ 材质：采用UL认可之尼龙66制成，防火等级94V-2，耐酸、耐蚀、绝缘性良好，不易老化、承受力强。
- ◆ 特点：可以松开重复使用
- ◆ Material: Nylon 66,94V-2 certified by UL. Heat-resisting, Acid & erosion contro,insulate well and not apt to age.
- ◆ Usage: releasable

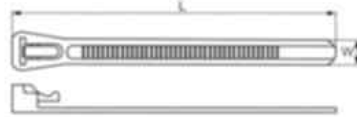

◆ 可松式尼龙扎带 (活型) Releasable Cable Ties

规格 ITEM.NO.	L(长) LNCH (mm)	W(宽) (mm)	捆扎范围 BLADE DIAMETER E(mm)	拉力 MIN LOOP TENSILE STRENGTH LBS	拉力 KGS
BL-7.6x200	8	200	7.6	45	22
BL-7.6x250	10	250	7.6	50	22
BL-7.6x300	12	300	7.6	50	22
BL-7.6x350	13 3/4	350	7.6	50	22
BL-4.8x780	30 3/4	780	4.8	230	18



标牌式尼龙扎带 Marker Nylon Cable Ties

- ◆ 材质：采用UL认可之尼龙66制成，防火等级94V-2，耐酸、耐蚀、绝缘性良好，不易老化、承受力强。
- ◆ 特别：扎带前端设有空白标牌，可用油性笔在上面标志记号。
- ◆ Material: Nylon 66,94V-2 certified by UL. Heat-resisting, Acid & erosion contro,insulate well and not apt to age.
- ◆ Feature: It is easy to mark on the space at front tip of ties with oil pen.

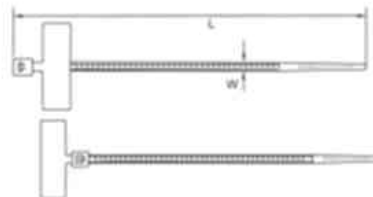

规格 ITEM.NO.	L(长) LNCH (mm)	W(宽) (mm)	捆扎范围 BLADE DIAMETER E(mm)	拉力 MIN LOOP TENSILE STRENGTH LBS	拉力 KGS	标牌尺寸 STANDARD SIZE (mm)
BL-2.5x70	3 3/16	70	2.5	18	8	25x80
BL-2.5x100	4	100	2.5	18	8	21x110
BL-2.5x110	4	110	2.5	18	8	25x8
BL-2.5x200	8	200	2.5	18	8	25x8
BL-3.6x150	6	150	3.6	40	18	21x110
BL-3.6x205	8	205	3.6	40	18	25x80

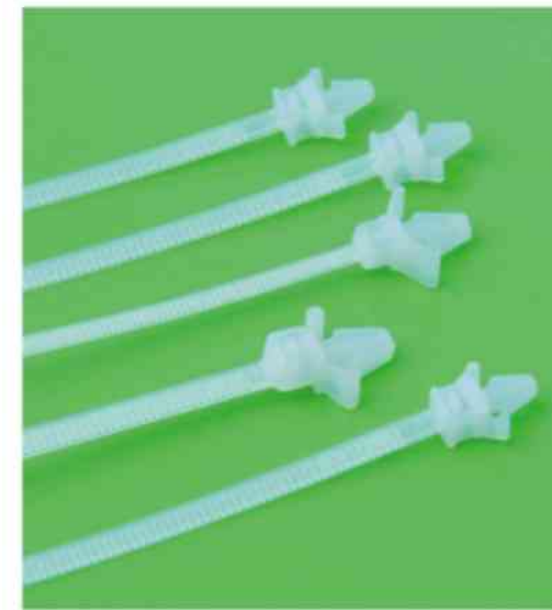
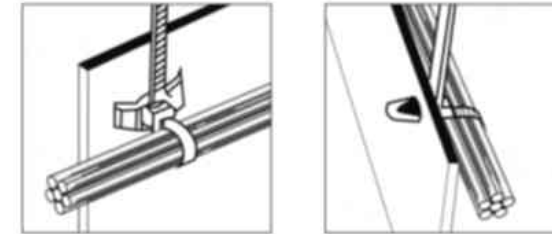

插销式尼龙扎带

- ◆ 材质：采用UL认可之尼龙66制成，防火等级94V-2，耐酸、耐蚀、绝缘性良好，不易老化、承受力强。
- ◆ 使用方法：先将机版钻孔，然后把扎带插入孔内，再将电线扎紧即可。

Push Mount Ties

- ◆ Material: Nylon 66,94V-2 certified by UL. Heat-resisting, Acid & erosion contro,insulate well and not apt to age.
- ◆ Usage: insert tie to the hole of table and tighten it.

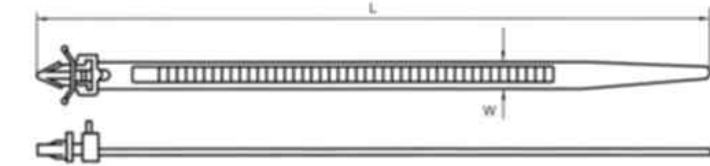

规格 ITEM.NO.	L(长) LNCH (mm)	W(宽) (mm)	捆扎范围 BLADE DIAMETER E(mm)	拉力 MIN LOOP TENSILE STRENGTH LBS	拉力 KGS	孔径(φ) HOLE DIA. INCH	孔径 MM	机版厚度 PANEL THICKNESS INCH	机版厚度 MM	
BL-2.5x100	4	100	2.5	22	18	8	0.189	4.8	0.094	2.4
BL-3.0x130	4 3/4	130	3.0	30	13.6	0.157	4.0	0.094	2.4	
BL-3.6x130	4 3/4	130	3.6	25	40	0.189	4.8	0.094	2.4	
BL-3.6x150	6	150	3.6	38	40	0.189	4.8	0.094	2.4	
BL-4.8x200	7 1/2	190	4.8	45	50	0.252	6.5	0.126	3.2	

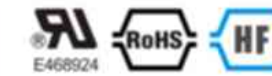

固定头式尼龙扎带

- ◆ 材质：采用UL认可之尼龙66制成，防火等级94V-2，耐酸、耐蚀、绝缘性良好，不易老化、承受力强。
- ◆ 特点：扎带捆扎电线后，将整束电线用螺钉固定于基板上。

Mountable Head Ties

- ◆ Material: Nylon 66, 94V-2 certified by UL. Heat-resisting, Acid & erosion control, insulate well and not apt to age.
- ◆ Usage: after bundling wires, fix them on plate with screw.

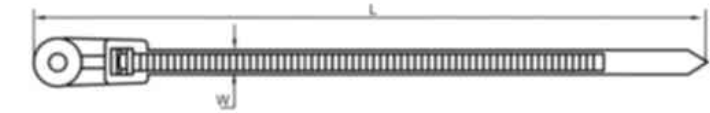

规格 ITEM.NO.	L(长) LNCH (mm)	W(宽) (mm)	捆扎范围 BLADE DIAMETER E(mm)	拉力 MIN LOOP TENSILE STRENGTH LBS	拉力 KGS
BL-100	4 1/4	100	3.5	22	18
BL-150	6	150	3.6	32	30
BL-200	8	200	4.8	42	40
BL-380	15	380	7.6	98	120

Cable Ties



反穿式尼龙扎带 Anti-Wear Nylon Cable Ties

- ◆ 材质: UL 合格之 NYLON 66(本色), 火等级 94V-2, 不易老化。
- ◆ 特点: 束紧光滑面向内, 齿列状向外, 故不会伤及表面较软的被束物, 没有压痕。
- ◆ Material: UL qualified NYLON 66 (character), fire rating 94V-2, not aging.
- ◆ Features: tighten smooth inner face, teeth-like outside, it will not hurt the surface softer wadding material, no indentation.



规格 ITEM.NO.	L(长) LNCH	(mm)	W(宽) (mm)	捆扎范围 BUNDLE DIAMETER E(mm)	拉力 MIN LOOP TENSILE STRENGTH LBS	KGS
BL-100	4	100	2.5	22	18	8
BL-120	4 3/4	120	2.5	30	18	8
BL-150	6	150	2.5	32	18	8
BL-150	6	150	3.6	32	40	18



平头式尼龙扎带 Flat nylon cable ties

规格 ITEM.NO.	L(长) LNCH	(mm)	W(宽) (mm)	捆扎范围 BUNDLE DIAMETER E(mm)	包装 PACKING
BL-200	8	200	4.8	45	100pcs
BL-250	10	255	9.0	74	
BL-400	15 1/2	400	9.0	117	

珠形字母扣 Mother Of Pearl-Shaped Buckle

- ◆ 材质: UL 合格之 NYLON 66(本色), 防火等级 94V-2, 不易老化。
- ◆ 用途: 一般电源线之绑扎, 可再松开重复使用。
- ◆ Material: UL qualified NYLON 66 (character), fire rating 94V-2, not aging.
- ◆ Purpose: Lashing general power line can be reused and then release.

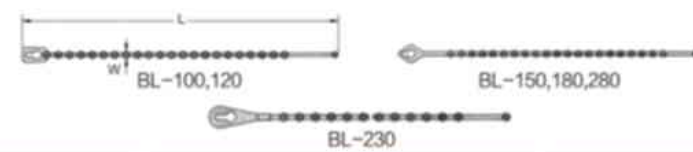

规格 ITEM.NO.	L(长) LNCH	(mm)	捆扎范围 BUNDLE DIAMETER E(mm)	包装 PACKING
BL-100	4	103	25	100pcs
BL-120	4 3/4	120	30	
BL-150	6	150	39	
BL-180	7	180	49	
BL-230	8 15/16	226	63	
BL-280	11	273	75	



Cable Ties



双拉珠孔线带 Twill Micropyle Line Bag

- ◆ 材质: NYLON 66(本色), PE(本色)二种。(拥有黑色)
- ◆ 特点: 一般电源线之绑扎, 可再解开重复使用。
- ◆ Material: NYLON 66 (color), PE (as) two. (black)
- ◆ Features: General LeiYuan line binding, can drive reuse beard again.

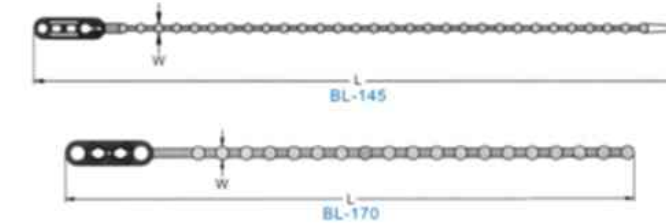

规格 ITEM.NO.				L(长)		W(宽) (mm)	捆扎范围 BUNDLE DIAMETER E(mm)	包装 PACKING
本色 ECRU	黑色 BLACK	本色 ECRU	黑色 BLACK	LNCH	(mm)			
BL-145	BL-145BK	BL-145E	BL-145EBK	5 3/4	145	2.0	35	100pcs
BL-150	BL-150BK	BL-150E	BL-150EBK	6	150	4.0	38	
BL-170	BL-170BK	BL-170E	BL-170EBK	6 9/16	167	3.5	41	
BL-180	BL-180BK	BL-180E	BL-180EBK	7	180	4.0	46	
BL-230	BL-230BK	BL-230E	BL-230EBK	8 15/16	230	4.0	62	



珠孔形尼龙扎带 Knot Ties

- ◆ 材质: 采用UL认可之尼龙66料制成, 防火等级 94V-2, 耐酸、耐蚀、绝缘性好不易老化、承受力强。
- ◆ 用途: 一般电源线之绑扎, 可再松开重复使用。
- ◆ Material: Nylon 66, 94V-2 certified by UL. Heat-resisting, Acid & erosion control, insulate well and not apt to age.
- ◆ Usage: releasable

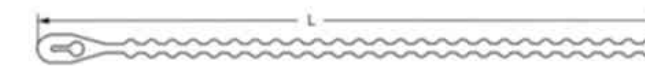

规格 ITEM.NO.	L(长) LNCH	(mm)	捆扎范围 BUNDLE DIAMETER E(mm)	拉力 MIN LOOP TENSILE STRENGTH LBS	KGS
BL-120	5 3/4	120	25	18	8
BL-150	6	150	35	18	8
BL-180	7	180	45	18	8
BL-250	10	250	65	18	8



Living on quality, Developing on credit!
信誉求发展, 质量求生存!

Value Pack

DBL 勃凌

Value Pack

组合性束带

- ◆ 适合家庭、园艺、汽车及海事业使用。
- ◆ 欢迎“OEM”。
- ◆ 可根据客户要求组合。

Diy Package Cable Tie

- ◆ Great for home, garden, auto and marine use
- ◆ "OEM" is acceptable.
- ◆ All the value pack are available as requested.



扎带包装系列 Packing Series

编号 ITEM.NO.	规格 SIZE(MM)	数量 Q'TY	颜色 COLOR	包装 PACKING
BL-50C	2.5 X 100	25PCS	Black(6), Red(7), Yellow(6), Blue(6)	Polybag with head card
	3.5 X 200	25PCS	Black(6), Red(7), Yellow(6), Blue(6)	
BL-50YL	2.5 X 100	25PCS	Yellow	
	3.5 X 200	25PCS	Yellow	
BL-50BK	2.5 X 100	25PCS	Black	
	3.5 X 200	25PCS	Black	
BL-50RD	2.5 X 100	25PCS	Red	
	3.5 X 200	25PCS	Red	
BL-50W	2.5 X 100	25PCS	Natural	
	3.5 X 200	25PCS	Natural	

编号 ITEM.NO.	规格 SIZE(MM)	数量 Q'TY	颜色 COLOR	包装 PACKING
BL-60W(B)	2.5 X 100	20PCS	Natural Or BLACK	Black pvc bag With head card
	3.5 X 150	20PCS		
	4.5 X 200	20PCS		
BL-70W(B)	2.5 X 100	20PCS	Natural Or BLACK	
	2.5 X 150	25PCS		
	3.5 X 200	25PCS		
BL-75W(B)	2.5 X 100	25PCS	Natural Or BLACK	Transparent pvc bag With head card
	2.5 X 150	25PCS		
	3.5 X 200	25PCS		
BL-85W(B)	2.5 X 100	30PCS	Natural Or BLACK	
	2.5 X 150	30PCS		
	3.5 X 200	25PCS		

编号 ITEM.NO.	规格 SIZE(MM)	数量 Q'TY	颜色 COLOR	包装 PACKING
BL-60B	2.5 X 100	25PCS	Black	Single Blister
	2.5 X 150	20PCS		
	3.5 X 200	15PCS		
BL-60W	2.5 X 100	25PCS	Natural	
	2.5 X 150	20PCS		
	3.5 X 200	15PCS		
BL-60C	2.5 X 100	25PCS	Red	
	2.5 X 150	20PCS	Yellow	
	3.5 X 200	15PCS	Blue	

Value Pack



编号 ITEM NO.	规格 SIZE(MM)	数量 Q'TY	颜色 COLOR	包装 PACKING
BL-300C	2.5 X 100	50PCS	Natural	Blister With insert card A
	2.5 X 100	50PCS	Black	
	2.5 X 100	50PCS	Red	
	2.5 X 100	50PCS	Yellow	
	2.5 X 100	50PCS	Blue	
	2.5 X 100	50PCS	Green	
BL-250A	2.5 X 100	100PCS	Natural	
	2.5 X 100	100PCS	Black	
	2.5 X 200	50PCS	Natural	
BC-250B	2.5 X 100	50PCS	Natural	
	2.5 X 100	50PCS	Red	
	2.5 X 100	50PCS	Yellow	
	2.5 X 100	50PCS	Green	
	2.5 X 200	50PCS	Blue	



编号 ITEM NO.	规格 SIZE(MM)	数量 Q'TY	颜色 COLOR	包装 PACKING
BL-75W	2.5 X 90	25PCS	Natural	Blister With insert card B
	4.5 X 120	25PCS		
	4.5 X 190	25PCS		
BL-100W	2.5 X 100	70PCS	Natural	
	2.5 X 150	20PCS		
	3.5 X 200	10PCS		
BL-200C	2.5 X 100	40PCS	Red	
	2.5 X 100	40PCS	Yellow	
	2.5 X 100	40PCS	Green	
	2.5 X 100	40PCS	Blue	
	2.5 X 100	40PCS	Black	



编号 ITEM NO.	规格 SIZE(MM)	数量 Q'TY	颜色 COLOR	包装 PACKING
BL-20W	2.5 X 100	20PCS	Natural	Black Blister
BL-20YL	2.5 X 100	20PCS	Yellow	
BL-20BL	2.5 X 100	20PCS	Blue	
BL-20GN	2.5 X 100	20PCS	Green	
BL-20RD	2.5 X 100	20PCS	Red	

Value Pack



小桶装组合
Small Barrel Combination

编号 ITEM NO.	规格 SIZE(MM)	数量 Q'TY	颜色 COLOR	包装 PACKING
BL-20N	2.5 X 100	700PCS	Natural	PVC JAR
BL-20B	2.5 X 100	700PCS	Black	
BL-700C	2.5 X 100	100PCS	Red	
		100PCS	Yellow	
		100PCS	Blue	
		100PCS	Green	
		100PCS	Orange	
		100PCS	Natural	
		100PCS	Black	



小桶装组合
Small Barrel Combination

编号 ITEM NO.	规格 SIZE(MM)	数量 Q'TY	颜色 COLOR	包装 PACKING
BL-150	2.5 X 100	50PCS	Red	PET JAR & SIZE: φ5.5 X H21.5cm Q'TY/CTN: 56 SETS CTN SIZE: 47 X 41.5 X 23cm
	3.5 X 200	50PCS	Blue	
BL-200	2.5 X 100	50PCS	Green	
		50PCS	Natural	
		50PCS	Blue	
		50PCS	Natural	
BL-250	2.5 X 100	50PCS	Red	
		50PCS	Yellow	
		50PCS	Black	
		50PCS	Blue	
		50PCS	Green	



中桶装组合 In The Barrel Combination

编号 ITEM NO.	规格 SIZE(MM)	数量 Q'TY	颜色 COLOR	包装 PACKING
BL-300	2.5 X 100	25PCS	Red	PET JAR & SIZE: φ8 X H21.5cm Q'TY/CTN: 20 SETS CTN SIZE: 42 X 34 X 23cm
		25PCS	Yellow	
		25PCS	Black	
	3.5 X 200	25PCS	Green	
		50PCS	White	
		50PCS	Red	
BL-400	2.5 X 100	200PCS	Natural	
	3.5 X 200	50PCS	Black	
BL-500	2.5 X 100	100PCS	Red	
		100PCS	Black	
		100PCS	Green	
		100PCS	Blue	
		100PCS	Yellow	



大桶裝組合 Big Barrel Combination

編號 ITEM NO.	規格 SIZE(MM)	數量 Q'TY	顏色 COLOR	包裝 PACKING
BL-450	2.5 X 100	200PCS	Natural	PET JAR S SIZE: φ 12 X H31cm Q'TY/CTN: 12 SETS CTN SIZE: 50 X 38 X 33cm
	3.5 X 150	100PCS	Natural	
	3.6 X 200	100PCS	Natural	
	4.8 X 300	50PCS	Natural	
BL-650	2.5 X 100	50PCS	Blue	
		50PCS	Red	
	50PCS	Yellow		
	50PCS	Black		
	100PCS	Natural		
	100PCS	Black		
BL-850	2.5 X 100	200PCS	Natural	
		100PCS	Blue	
100PCS		Red		
100PCS		Yellow		
100PCS		Green		
100PCS		Natural		
BL-1000	3.6 X 200	200PCS	Black	
		100PCS	Natural	
	3.6 X 280	50PCS	Natural	
		100PCS	Blue	
	2.5 X 100	100PCS	Red	
		100PCS	Yellow	
100PCS		Natural		
100PCS		Blue		
3.5 X 150	100PCS	Green		
	100PCS	Natural		
3.6 X 200	200PCS	Natural		
	3.6 X 300	100PCS	Natural	
BL-1200	2.5 X 100	100PCS	Blue	
		100PCS	Red	
		100PCS	Yellow	
		100PCS	Green	
		100PCS	Orange	
		200PCS	Natural	
2.5 X 200	400PCS	Natural		
	3.6 X 300	100PCS	Natural	
BL-1500	2.5 X 100	100PCS	Blue	
		100PCS	Red	
		100PCS	Yellow	
		100PCS	Green	
		100PCS	Orange	
		200PCS	Natural	
2.5 X 150	100PCS	Natural		
	100PCS	Black		
	2.5 X 200	400PCS	Natural	
	3.6 X 280	200PCS	Natural	



不銹鋼噴塗扎帶 Stainless Steel Epoxy Coated Cable Ties

材料: 採用不銹鋼304、316材質, 外噴環氧樹脂熱固性粉末塗料, 各種長度皆可製作, 接受合理的OEM。

特性: 耐酸、耐腐蝕、不易燃燒、抗張强度高, 使用簡單, 滾珠式結構使的BC型扎帶具有簡單、快捷、不可解開等上的優勢。

工作溫度範圍: -40°C ~ 85°C

Overview:

They have a unique ball locking with plastic jetting mechanism, that allow easily and quickly installed and not undone.

High tensile strength, Non-flammability.

Working temperature -40°C ~ 85°C

High resistance to acetic acid, alkali acid, sulphuric acid, corrode.....etc

All length/Color are available, Stainless steel type: 304, 316

規格 (ITEM NO.)	L (長) MM	W (寬) MM	(最大)捆扎範圍 MAX. BUNDLE DIA(mm)	拉力 TENSILE STRENGTH
SST-100	HST-100	100	4.6	100 46
SST-152	HST-152	152	4.6	100 46
SST-175	HST-175	175	4.6	100 46
SST-200	HST-200	200	4.6	100 46
SST-250	HST-250	250	4.6	100 46
SST-300	HST-300	300	4.6	100 46
SST-360	HST-360	360	4.6	100 46
SST-400	HST-400	400	4.6	100 46
SST-520	HST-520	520	4.6	100 46
SST-600	HST-600	600	4.6	100 46
SST-680	HST-680	680	4.6	100 46
SST-840	HST-840	840	4.6	100 46
SST-1050	HST-1050	1050	4.6	100 46
SLT-152	HLT-152	152	7.9	176 80
SST-175	HST-175	175	7.9	176 80
SLT-200	HLT-200	200	7.9	176 80
SST-250	HST-250	250	7.9	176 80
SLT-300	HLT-300	300	7.9	176 80
SLT-360	HLT-360	360	7.9	176 80
SST-400	HST-400	400	7.9	176 80
SLT-520	HLT-520	520	7.9	176 80
SST-600	HST-600	600	7.9	176 80
SLT-680	HLT-680	680	7.9	176 80
SLT-840	HLT-840	840	7.9	176 80
SLT-1050	HLT-1050	1050	7.9	176 80
SBT-152	HBT-152	152	12	264 120
SST-175	HST-175	175	12	264 120
SBT-200	HBT-200	200	12	264 120
SST-250	HST-250	250	12	264 120
SBT-300	HBT-300	300	12	264 120
SBT-360	HBT-360	360	12	264 120
SBT-400	HBT-400	400	12	264 120
SBT-520	HBT-520	520	12	264 120
SST-600	HST-600	600	12	264 120
SBT-680	HBT-680	680	12	264 120
SBT-840	HBT-840	840	12	264 120
SBT-1050	HBT-1050	1050	12	264 120

◆ 特殊規格歡迎定做。

◆ 以上所有規格之不銹鋼扎帶的帶身皆可噴塗。

◆ 所有噴塗產品的編號另加 "P", 如 "SST-100P" 或 "HST-100P"。

◆ Other size are available as requested.

◆ The body of the above specification stainless steel cable ties can be plastic-coating

◆ All item No. of plastic-coating products should plus "P", such as "SST-100P" or "HST-100P"



Living on quality, Developing on credit!
信誉求发展, 质量求生存!

- R type clamp combination
- Trapezia Type
- Fusg Bibe Shape Head Ties
- Spiral Wrapping Bands
- Flat Cable Clips
- Plactic Security Seals

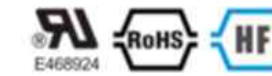

线夹组合装 CABLE CLAMPS

- ◆ 材质: UL合格之NYLON66(本色), 防火等级94V-2。
- ◆ 使用方法: 将电缆套入扣环中(如附图), 再以螺丝固定。
- ◆ 用途: 电线、电子、冷气配线之固定用。
- ◆ Material: UL qualified of NYLON66 (color), fire rating 94 v - 2.
- ◆ How to use: To set the cable into the Nuhuan (such as the appended drawings), again with screws.
- ◆ Application: Electrical wiring, electronics, wiring fixed with air conditioner.

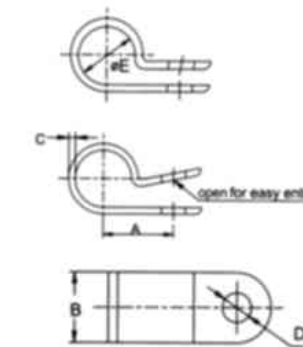

Part No.	E mm(inch)	A mm(inch)	B mm(inch)	C mm(inch)	Screw Dia. D mm	Packing
BL-1/8	2.9 (0.114)	9.1 (0.358)	12.7 (0.500)	1.5 (0.059)	5.4 for M5	100pcs
BL-1/4	5.9 (0.232)	11.4 (0.449)	12.7 (0.500)	1.5 (0.059)	5.3 for M5	
BL-3/8	9.1 (0.358)	13.4 (0.528)	12.1 (0.476)	1.5 (0.059)	5.3 for M5	
BL-1/2	12.2 (0.480)	15.0 (0.591)	12.7 (0.500)	1.5 (0.059)	5.3 for M5	
BL-9/16	13.8 (0.543)	15.8 (0.622)	12.7 (0.500)	1.5 (0.059)	5.3 for M5	
BL-3/4	18.6 (0.732)	19.8 (0.780)	12.7 (0.500)	1.5 (0.059)	5.3 for M5	
BL-7/8	21.8 (0.858)	21.4 (0.843)	12.7 (0.500)	1.5 (0.059)	5.3 for M5	
BL-1-1/8	27.9 (1.098)	24.6 (0.969)	12.7 (0.500)	1.5 (0.059)	5.3 for M5	
BL-5/8L	7.6 (0.299)	10.6 (0.417)	12.7 (0.500)	1.27 (0.050)	4.4 for M4	



线夹组合装 CABLE CLAMPS

编号 ITEM NO.	规格 SIZE (MM)	数量 Q'TY	颜色 COLOR	包装 PACKING
BL-80W	CHR-6mm	20PCS	White	Double Blister C
	CHR-7mm	20PCS		
	CHR-8mm	20PCS		
	CHR-9mm	20PCS		
BL-80B	CHR-6mm	20PCS	Black	
	CHR-7mm	20PCS		
	CHR-8mm	20PCS		
	CHR-9mm	20PCS		

Fusg Bibe Shape Head Ties Trapezia Type/Spiral Wrapping Bands

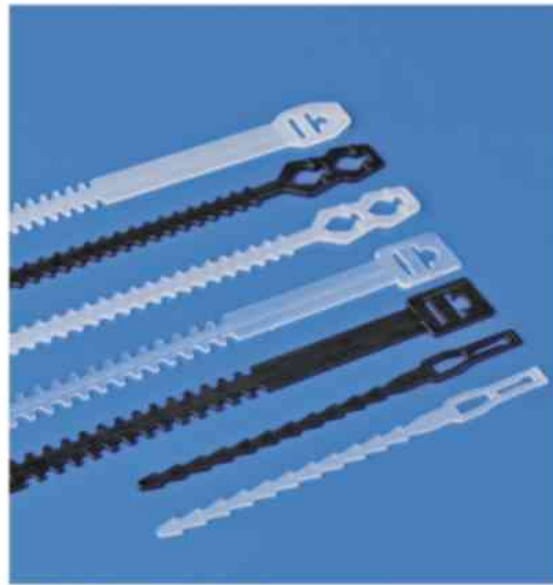

鱼骨束线带 Fusg Bibe Shape Head Ties

- ◆ 材质: PE料制成, 本色白色, 另拥有黑色。
- ◆ 使用方法: 先将电源线穿过A处, 使结束带与电源线连为一体, 然后将电线卷起, 将结束带扣上即可。
- ◆ 用途: 一般电源线收线用。
- ◆ Material: Made of PE material, nature is white, also prepared black.
- ◆ How to use: First the wire passes through A, connect the binding band with wire, then roll the wire, tie binding band.
- ◆ Application: Drawing for general wire.

规格 ITEM NO.	L (长) MM	W (宽) MM	(最大)捆扎范围 MAX. BUNDLE DIA. (mm)	包装 PACKING
BL-140	140	9	30	1000PCS
BL-155	155	9	35	1000PCS
BL-160	160	9	40	1000PCS
BL-200	200	9	50	1000PCS
BL-210	210	9	55	1000PCS

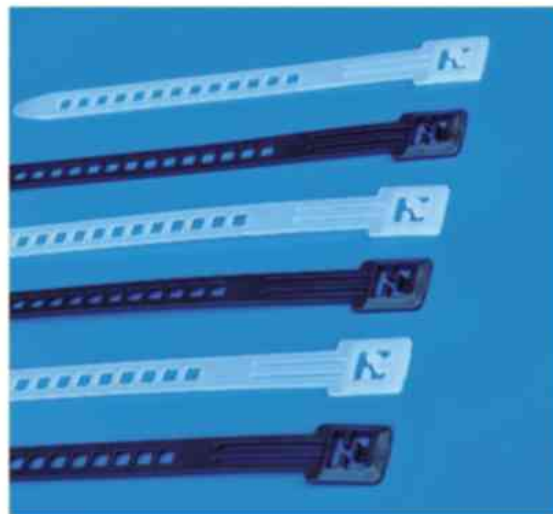

梯形束线带 Trapezoidal beam Line With

- ◆ 材质: PE料制成, 本色白色, 另拥有黑色。
- ◆ 使用方法: 先将电源线穿过A处, 使结束带与电源线连为一体, 然后将电线卷起, 将结束带扣上即可。
- ◆ 用途: 一般电源线收线用。
- ◆ Material: Made of PE material, nature is white, also prepared black.
- ◆ How to use: First the wire passes through A, connect the binding band with wire, then roll the wire, tie binding band.
- ◆ Application: Drawing for general wire.

规格 ITEM NO.	L(长) MM	W(宽) MM	(最大)捆扎范围 MAX. BUNDLE DIA. (mm)	包装 PACKING
BL-125	125	9	25	1000PCS
BL-140	140	9	30	1000PCS
BL-150	150	9	35	1000PCS
BL-178	170	9	40	1000PCS
BL-210	210	9	55	1000PCS
BL-250	250	9	65	1000PCS



卷式束线保护带(缠绕管) Spiral Wrapping Bands

- ◆ 材质: 采用PE料制成。
- ◆ 使用方法: 先用保护带固定起点一端, 然后按顺时针方向环绕束线, 即可将电线束为一体。
- ◆ 用途: 作为保护电线不受磨损及绝缘用, 并可改进电线弯曲的美观。
- ◆ Material: Made from PE.
- ◆ How to use: Fix one end with safety belt first, then circle the wires clockwise to make them tighen.
- ◆ Application: A protection wear for electric wires, and make them insulation and look nice.

规格 ITEM NO.	内径(D) MM	外径(D) MM	螺距(W) MM	捆扎范围 WRAPPING RANGE (mm)	包装 PACKING
BL-03	1.5	3.0	4.0	1.5-10	10MROLL
BL-06	4	6	7.0	4-50	
BL-08	6	8	10.8	6-60	
BL-10	7.5	10	11.4	7.5-60	
BL-12	9	12	13.9	9-65	
BL-15	12	15	15.0	12-75	
BL-19	15	19	18.2	15-100	
BL-24	20	24	19.6	20-130	
BL-30	26	30	43.0	26-150	

Flat Cable Clips/Plactic Security Seals



扁型钢钉线卡 Flat Cable Clips

- ◆ 本系列线卡均采用PE(白色、灰色)料注射成型, 弹性大, 耐冲击, 绝不破裂。
- ◆ 本系列线卡, 均为插钉式, 钢钉直接附在线卡上, 可大量节省工时, 降低施工成本。
- ◆ PE(white, grey), elasticity and shockresisting.
- ◆ Inserting type, nail attached in clips. Save time and cost.

规格 ITEM NO.	高(H) MM	A	B	钢钉 NAIL	颜色 Color
BL-2.5MM	3.5	2.0	2.5	1.4 X 15	WHITE GREY BLACK BROWN DARK GREY
BL-4MM	5.5	3.5	4	1.7 X 14	
BL-5MM	5.5	3.5	5	1.7 X 14	
BL-6MM	6.0	4.1	6	1.7 X 16	
BL-7MM	6.5	4.7	7	1.9 X 16	
BL-8MM	7.0	5.0	8	2.1 X 19	
BL-9MM	8.0	5.4	9	2.1 X 20	
BL-10MM	8.0	5.6	10	2.3 X 21	
BL-12MM	8.5	5.6	12	2.3 X 23	
BL-14MM	10.0	7.0	14	2.3 X 23	
BL-16MM	12.5	8.5	16	2.6 X 27	
BL-19MM	14.0	10.5	19	2.6 X 27	

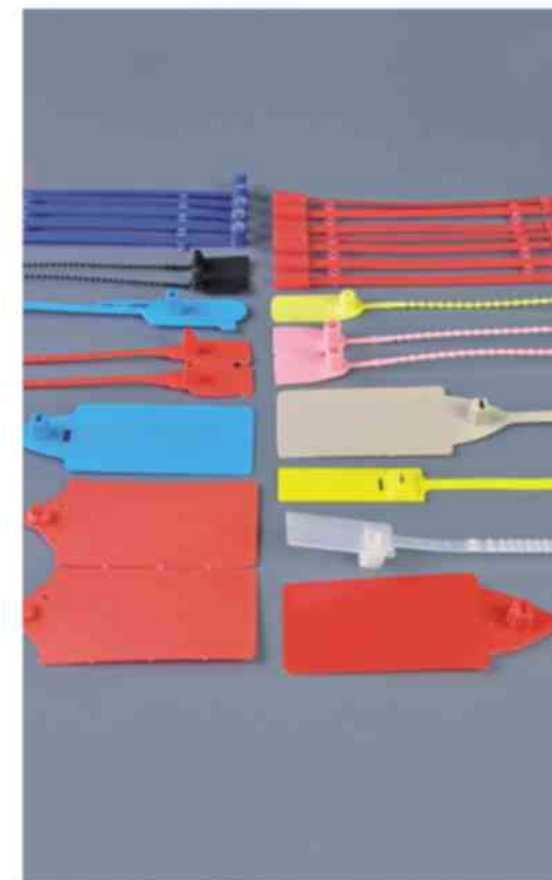
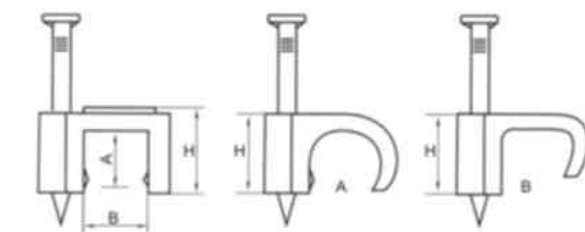

塑料安全条 Plactic Security Seals

- ◆ 材质: 采用UL认可之尼龙66料制成, 防火等级94V-2耐酸、耐碱、绝缘性良好, 不易老化, 承受力强。
- ◆ 适用于金融、航运、电力、集装箱等行业的保密用途。
- ◆ 标贴上可按客户要求印上名称、商标、日期、流水号等内容。
- ◆ Material: Nylon 66, 94V-2 certified by UL. Heat-resisting, Acid & erosion control, insulate well and not apt to age.
- ◆ Apply to financial services, shipping, electricity, container and other industries.
- ◆ Customer name, trademark, date, serial number etc. are allowed to be printed on the marker

规格 ITEM NO.	L (长) MM	W (宽) MM	(最大)捆扎范围 MAX. BUNDLE DIA. (mm)	标贴尺寸 STICKER SIZE
BL-230	230	3.9	42	12 X 30
BL-350	350	7.7	70	20 X 45
BL-450	450	9	66	55 X 106

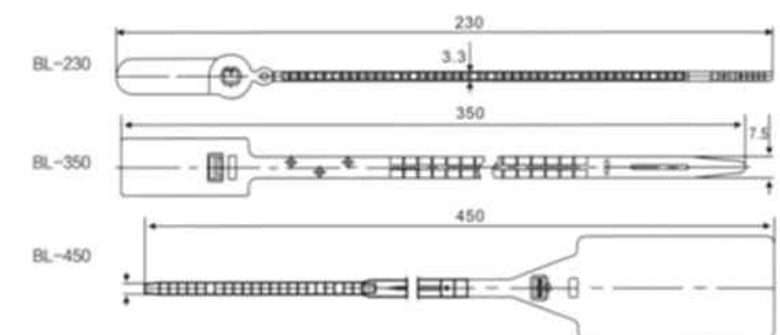



尼龙电缆固定头 Cable Glands

- ◆ 腺体经得起温度。高达140°C以上(284°F)在很短的时间。
- ◆ 材料：尼龙6,6, UL94 V2, 氯丁橡胶密封插入, 螺母
- ◆ 颜色：黑色, 灰色, 浅灰色
- ◆ The gland can stand the temp. up to 140°C(284°F) in short time.
- ◆ Material: polyamide 6,6, UL94 V2. Neoprene for seal insert, with nut
- ◆ Color: Black, grey, light grey

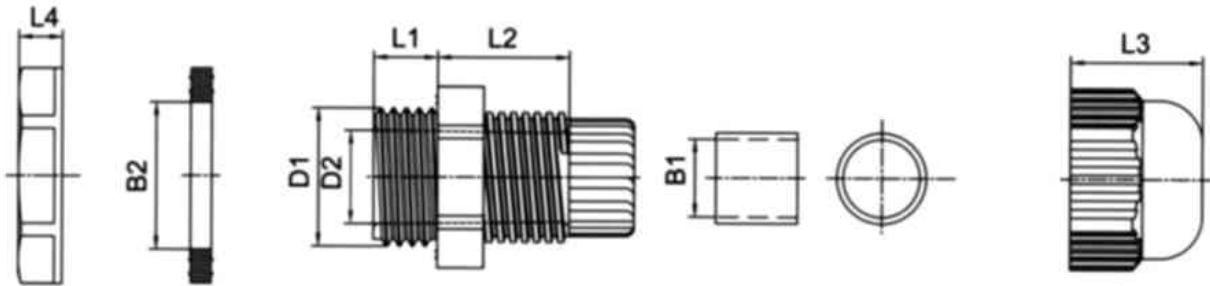

Lock nut Washer Body Seal Sealing Nut

规格 Part.No.	Mounting Hole Dia (mm)	D1 (mm)	D2 (mm)	B1 (mm)	B2 (mm)	L1 (mm)	L2 (mm)	L3 (mm)	L4 (mm)	Cable Range	Package (pcs/bag)
PG Gland Range											
BL-07	13.0	12.5	7.5	7.2	12.5	8.0	14.5	13	5	3-6.5	100
BL-09	15.7	15.2	10.0	9.9	15.2	8.0	15.5	15.3	5	4-8	100
BL-11	19.1	18.6	13.5	13.1	18.6	8.0	17.0	17.5	5	5-10	100
BL-13.5	20.9	20.4	13.5	13.1	20.4	10.0	17.0	17.5	6	6-12	100
BL-16	23.0	22.5	17.5	17.0	22.5	10.0	19.0	19.5	6	10-14	100
BL-21	28.8	28.3	21.4	21.0	28.3	10.0	21.2	25	7	13-18	100
BL-29	37.5	37.0	28.8	28.0	37.0	11.0	23.4	25.5	7	18-25	100
BL-36	47.5	47.0	36.5	35.3	47.0	12.0	27.8	30	8	22-32	100
BL-42	54.5	54.0	38.5	38.0	54.0	14.6	31.0	32	8	28-38	100
BL-48	59.8	59.3	46.0	45.5	59.3	15.5	30.6	34.5	8	35-45	100

Metric Gland Range											
规格 Part.No.	Mounting Hole Dia (mm)	D1 (mm)	D2 (mm)	B1 (mm)	B2 (mm)	L1 (mm)	L2 (mm)	L3 (mm)	L4 (mm)	Cable Range	Package (pcs/bag)
M12	12.5	12	7.5	7.2	12.5	8.0	14.5	13.0	5	3-6.5	100
M16	16.5	16	11.0	9.9	16.5	7.5	15.5	15.3	5	4-8	100
M20	20.5	20	17.5	17.0	20.5	10.0	19.0	19.5	6	10-14	100
M25	25.5	25	21.4	21.0	25.5	11.0	21.2	25.0	6	13-18	100
M32	32.5	32	27.0	28.0	32.5	10.3	23.4	25.5	7	18-25	50
M40	40.5	40	36.5	35.3	40.5	12.0	27.8	30.0	7	22-32	50
M50	50.5	50	38.5	38.0	50.5	12.0	31.0	32.0	8	28-38	50
M63	63.5	63	46.0	45.5	63.5	15.5	30.6	34.5	8	35-45	50



Living on quality, Developing on credit!
信誉求发展, 质量求生存!

Safety-type Wire Joints
Terminal Blocks
All Plastics Connectors
Power line deduction
Nylon Flexible Conduit

Safety-type Wire Joints



闭端子 Closed Terminal

- ◆ 外壳材质: UL 认可之尼龙66, 防火等级94V-2。
- ◆ 使用方法: 将电线尾部外皮剥去再插入套管内, 用压线钳压紧即可。
- ◆ 特点: 外壳为尼龙注塑成型, 内部铜管特长, 增加电线压接范围使其更易于导电, 并能夹紧住电线, 即使强烈震动亦不脱落。
- ◆ Shell material: Nylon 66, 94V-2, certificated agree, by UL.
- ◆ Usage: Peel the coat of wire, then insert to tube, use pincers to fix them.
- ◆ Feature: Nylon shell, long copper tube, easy to conduct electricity and hold wire tightly.

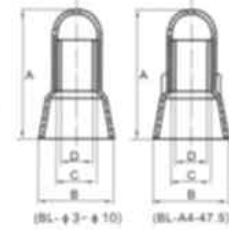

规格 ITEM.NO.	A(高) MM	W(宽) B(MM)/C(MM)	铜管内径 D(MM)	适用电线范围 MM ²	SUITABLE WIRES AWG
BL-φ3	18	9	3.6	2.8	22-16
BL-φ4	21	9.5	3.9	3	16-14
BL-φ5	22.5	10.5	4.8	4	12-10
BL-φ6	24	12	5.6	4.8	8
BL-φ7	25.5	13	6.5	5.5	8-6
BL-φ8	25.5	14	7.5	6	6
BL-φ10	29.5	15.5	9.3	7.8	4



螺旋式压线帽 All Plastics Connectors

规格 ITEM.NO.	高(H) MM	宽(W) MM	内径(D) MM	适用电线 SUITABLE WIRES	颜色 Color
BL-N71	15	8.5	6.5	MN#20 x 1 + #22 x 1 MAX#16x2	灰 Grey
BL-N72	18	10	7.5	MN#20 x 3 MAX#16x3	蓝 Blue
BL-N73	20	11.5	9.5	MN#20 x 3 MAX#16x3+#18 x 1	橘红 Orange
BL-N74	23.5	13.5	10.8	MN#14x 1+#18 x 1 MAX#14x4+#18 x 1	黄 Yellow
BL-N75	23.5	15.5	12.7	MN#14x2 MAX#10x2+#12x2	红 Red



接线端子 Terminal Blocks

- ◆ 接线端子H, U(W), V(F)型
- ◆ 材质: 采用PA, PE或PP料制成。
- ◆ TERMINAL BLOCKSH. U(W), V(F) TYPE
- ◆ Material: made from PA, PE or PP.

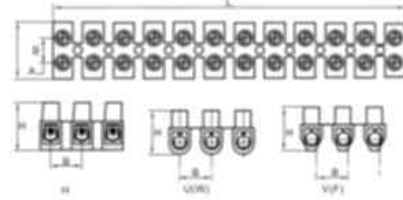

规格 ITEM.NO.	L	W	H	A	B	MM ²	VOLT	AMP	包装 PACKING
BL-3A	90.3	15.5	11.5	6	7.7	4	400V	3A	10PCS
BL-6A	110.5	15.5	12.4	6.5	9.5	6	400V	6A	
BL-10A	116.7	20	14.9	8	10	10	400V	10A	
BL-16A	136.8	21.5	16.7	10	11.7	12	400V	16A	
BL-20A	153.5	24.5	17.4	11.5	13.2	14	400V	20A	
BL-30A	165	25	20	12	14.1	16	400V	30A	
BL-60A	187.6	29	23.5	12	16	25	400V	60A	
BL-80A	205	33	27	15	17	35	400V	80A	
BL-100A	250	46	31	22	21	40	400V	100A	

Power line deduction/Nylon Flexible Conduit



电源线扣 Power line deduction

- ◆ 本系列线卡均采用PE(白色、灰色)料注射成型, 弹性大, 耐冲击, 绝不破裂。
- ◆ 本系列线卡, 均为插钉式, 钢钉直接附在线卡上, 可大量节省工时, 降低施工成本。
- ◆ PE(white, grey), elasticity and shockresisting.
- ◆ Inserting type, nail attached in clips. Save time and cost.

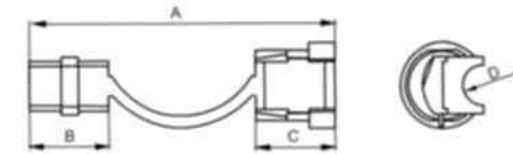

规格 ITEM.NO.	A	B	C	D	安装孔径 HOLE DIA.
A3	72.0	18.0	18.0	φ12.0	φ18.0
A4	42.0	11.5	11.5	φ5.0	φ13.0
A5	38.0	14.0	14.0	φ6.0	φ14.0
A6	34.0	10.0	10.0	φ4.0	φ9.0
A7	30.0	10.0	10.0	φ4.0	φ11.0
A8	41.0	11.0	11.0	φ5.0	φ12.0
A9	46.0	12.0	12.0	φ5.0	φ10.0



尼龙波纹管 Nylon Flexible Conduit

- ◆ 材质: UL 合格之NYLON 6(黑色), 防火等级94HB。
- ◆ 用途: 适用于电缆之保护。
- ◆ 特点: 弹性佳, 可塑性良好。
- ◆ Material: UL qualified NYLON 6 (black), such as fire prevention 94 hb.
- ◆ Application: suitable for the protection of the cable.
- ◆ Characteristics: good elasticity, plasticity is good.

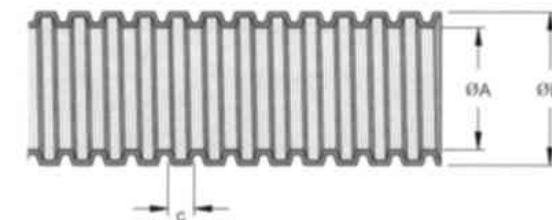

规格 ITEM.NO.	Inch	ØA	ØB	C	包装 Packing
BL-07	1/4"	6.6±0.4	10.0±0.4	2.4	50M
BL-10	5/16"	9.8±0.4	13.0±0.4	2.0	
BL-12	3/8"	12.2±0.4	15.8±0.4	2.1	
BL-17	1/2"	16.8±0.4	21.7±0.4	2.3	
BL-23	3/4"	23.0±0.4	28.5±0.4	2.3	
BL-29	1"	28.6±0.4	34.4±0.4	2.5	
BL-36	1 1/4"	35.8±0.4	42.5±0.5	2.0	
BL-48	2"	47.5±0.4	54.5±0.5	2.0	



Living on quality, Developing on credit!
 信誉求发展, 质量求生存!

Wire Clip
 Button Harness Seat
 Flat Cable Clips
 Cable Clip
 Adjustable Cable Clamp
 Spacers



扎线固定座 Wire Clip

- 材质: UL合格之NYLON66,防护等级94V-2。
- 用途: 螺丝固定; 搭配扎带, 收线范围广, 可以重复使用。
- 特点: 螺丝孔螺丝固定。
- Material: UL qualified NYLON66, protection grade 94 v - 2.
- USES: screws; The line in collocation tie, range. Can be repeated use.
- Features: the screw hole screws.

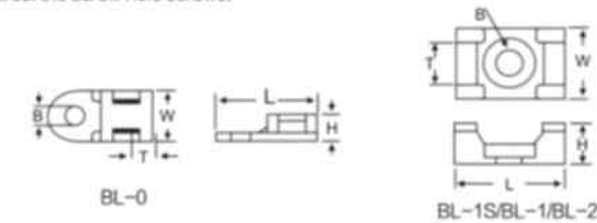

规格 ITEM.NO.	B	W	T	H	L	包装 Packing
BL-0	φ3.8	9.5	5.5x2.5	5.0	19.7	5000pcs
BL-1	φ3.2	10.2	5x2	7.0	15	5000pcs
BL-2	φ5.0	16	9x3.5	9.6	23	500pcs
BL-2-6.0	φ6.0	16	9.0	9.0	23	500pcs

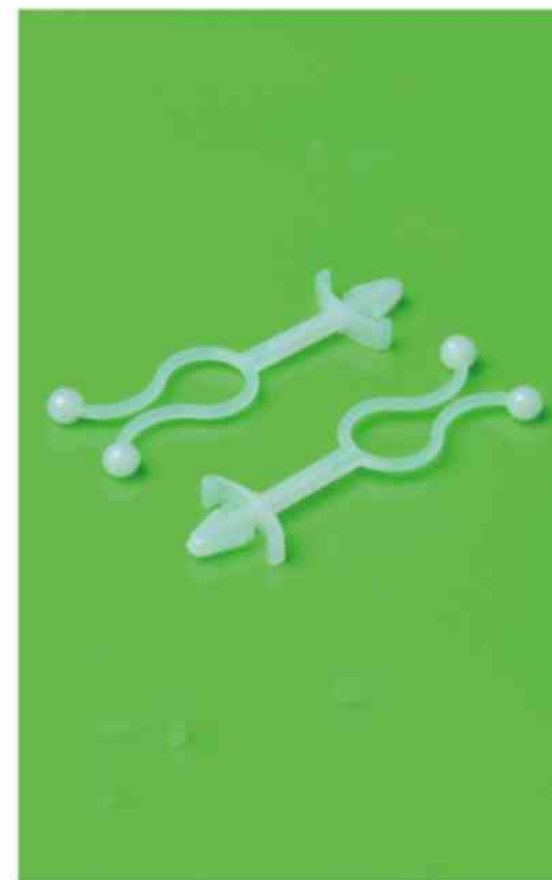

扣式束线座 Button Harness Seat

- 材质: UL合格之NYLON66,防护等级94V-2。
- 用途: 可快速固定电线, 安装容易, 美观。
- Material: UL qualified NYLON66, protection grade 94 v - 2.
- USES: Can be quickly fixed wire, easy to install, and beautiful.

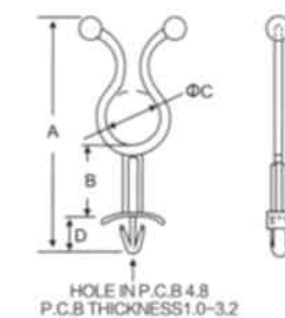

规格 ITEM.NO.	A	B	C	D	束线径 Cable diameter	包装 Packing
BL-4010	40	2.5	10	10.6	/	1000pcs
BL-5510	55	20	10	10.6	/	
BL-3205	32	2.5	5	10.6	/	
BL-3306	33	2.5	6	10.6	/	
BL-4415	44	2.5	15	10.6	/	
BL-5314	53	12.0	14.0	10.6	/	
BL-08	43.8	10.5	8.0	10.6	6.8	
BL-11	56.8	20.0	10.8	10.6	9.8	
BL-15	59.3	20.4	15.0	10.6	13.8	
BL-20	63.5	16.2	20.0	10.6	18.4	



配线固定座 Wiring Fixing Seat

- ◆ 材质: UL合格之NYLON 66, 防护等级94V-2。
- ◆ 颜色: 本色/黑色。
- ◆ 背胶: 3M胶粘贴, 可省去钻孔。尼龙扎带穿孔固定电线, 可以重复使用。
- ◆ 用途: 使用时将底面胶带撕去封纸, 再将固定座粘贴于机板上, 扎带穿进扎带孔收紧固定电线, 背胶式可省去面板钻孔。
- ◆ 特点: 背胶式可快速固定固定座, 扎带束线维修方便, 不占空间。
- ◆ Material: NYLON 66 UL qualified, protection grade 94 v - 2.
- ◆ Color: grey/black.
- ◆ Material: Lamination: 3 m adhesive stickers, can save drilling. Fixed wire, cable tie perforation can be repeated use.
- ◆ Purpose: when using tear bottom tape to seal paper, then fixed paste on the boards, cable tie wear fixed wire into the cable tie hole tighten, back glue type drilling machine board.
- ◆ Characteristic: the back glue can be quickly fixed mount, cable tie beam line maintenance convenient, does not occupy a space.

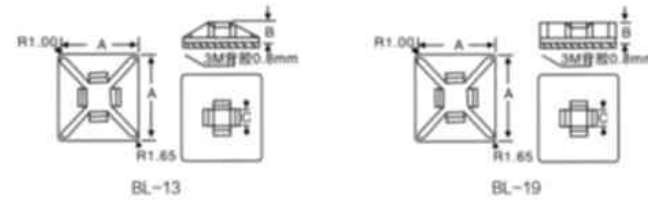

规格 ITEM.NO.	A	B	穿孔孔C Threading hole	包装 Packing
BL-13	13.0	4.8	3 X 2	500pcs
BL-19	19.0	4.8	4 X 2	500pcs



粘贴式扭扣环 Cable Clip

- ◆ 材质: UL合格之NYLON 66, 防护等级94V-2。
- ◆ 颜色: 本色/黑色。
- ◆ 用途: 固定电线
- ◆ 用法: 使用时将底面胶带撕去封纸, 再将固定座贴于机板上, 电线穿于孔中, 即可使用, 可省去面板钻孔。
- ◆ 特点: 粘贴式设计, 可省去面板钻孔, 束线简单牢固, 整理电线齐整美观, 并可以松开重复使用。
- ◆ Material: NYLON 66 UL qualified, protection grade 94 v - 2.
- ◆ Color: grey/black.
- ◆ Application: the fixed wiring
- ◆ Usage: when using tear bottom tape to seal paper, then stick in the machine fixed seat plate, wire wear in the hole, can use, can save drilling panel.
- ◆ Features: paste type design, can save drilling panel, simple solid beam line. Wire and neat and beautiful, and you can loosen the repeated use.



规格 ITEM.NO.	A	B	C	D	束线范围 Cable range	包装 Packing
BL-08	22.7	20.0	12.6	8.0	4-8	500pcs
BL-09	22.7	20.0	12.6	9.0	5-9	
BL-15	35.0	22.0	13.0	15.0	13-17.8	

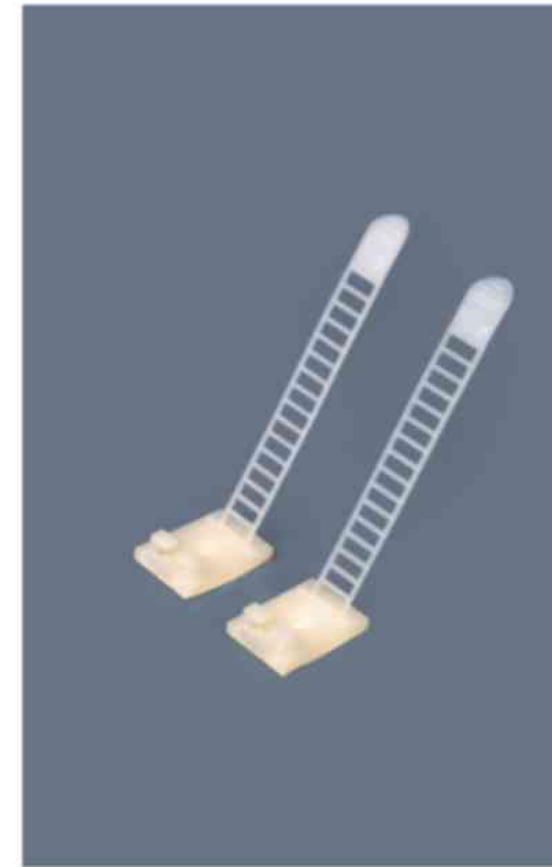

可调式电线固定座 Adjustable Cable Clamp

- ◆ 材质: UL合格之NYLON 66, 防护等级94V-2。
- ◆ 颜色: 本色/黑色。
- ◆ 用途: 固定电线
- ◆ 用法: 背胶式固定和有固定孔, 可以粘贴式固定和螺丝固定; 扣式梯级锁线。收线范围广泛, 可以重复使用。
- ◆ 特点: 背胶式, 可快速拆卸, 固定电线维修方便, 不占空间。
- ◆ Material: NYLON 66 UL qualified, protection grade 94 v - 2.
- ◆ Color: grey/black.
- ◆ Application: the fixed wiring
- ◆ Usage: lamination type fixed and a fixed hole, and paste type screw fixation; Button cascade locking wire. The line is wide. Can be repeated use.
- ◆ Features: back glue type, can quickly remove, fixed wire and convenient maintenance, does not occupy a space.

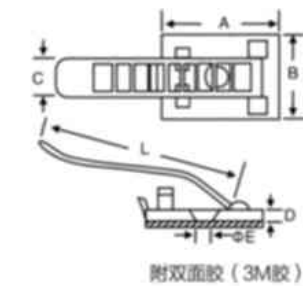

规格 ITEM.NO.	A	B	C	D	E	L	束线范围 Cable range	包装 Packing
BL-13	25.4	18.0	8.4	2.4	Φ3-Φ4	64.0	Φ13	500pcs
BL-17	25.4	18.0	8.4	2.4	Φ3-Φ4	90.0	Φ17	500pcs
BL-22	30	21.0	12.4	2.4	Φ4-Φ4.5	90.0	Φ22	100pcs
BL-26	30	21.0	12.4	2.4	Φ4-Φ4.5	90.0	Φ26	100pcs

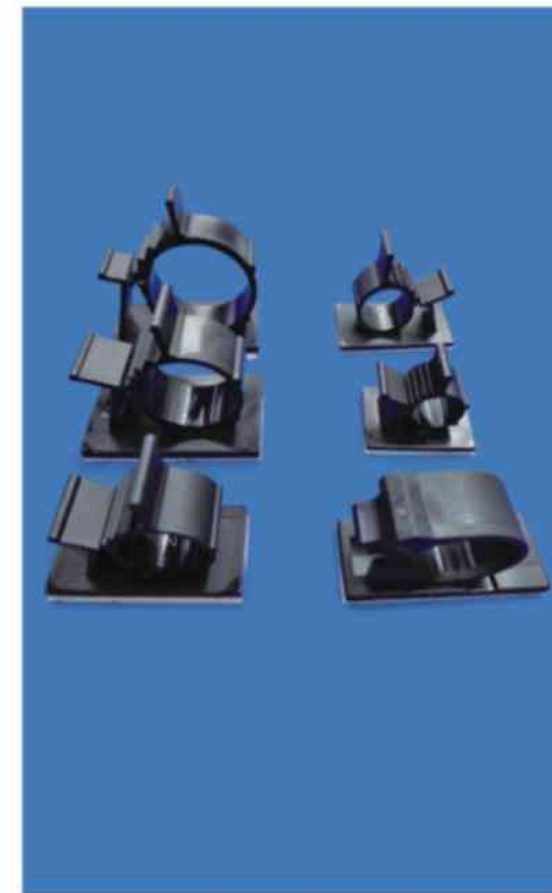

可调式固定座 Adjustable Cable Clamp

- ◆ 材质: UL合格之NYLON 66, 防护等级94V-2。
- ◆ 颜色: 本色/黑色。
- ◆ 用途: 固定电线
- ◆ 用法: 使用时将底面胶带撕去封纸, 再将固定座贴于机板上, 电线穿于孔中, 即可使用, 可省去面板钻孔。
- ◆ 特点: 背胶式装配简单、快速、牢固、开启容易, 可多次重复使用
- ◆ Material: UL qualified NYLON 66, protection class 94V-2.
- ◆ Color: gray / black.
- ◆ Purpose: Fixed Wire
- ◆ Usage: When using the bottom surface of the tape seal torn paper, and then the anchor plate affixed to the machine, wire through the hole, and can be used, eliminating the need for panel drilling.
- ◆ Features: adhesive type assembly is simple, fast, strong, open easily, can be used repeatedly

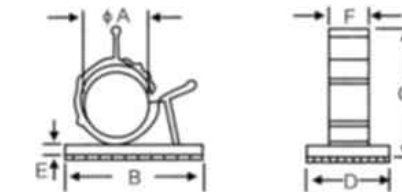

规格 ITEM.NO.	束扎范围 Bunch Diameter A(mm)	B(mm)	C(mm)	D(mm)	E(mm)	F(mm)	包装 PACKING
BL-0810	7.9-10.3	25.4	22.2	19.1	1.6	10.2	100pcs
BL-1013	10-12.5	31.8	27.8	19.1	1.6	10.2	
BL-1316	12.6-15.4	38.1	31.8	19.1	1.6	12.7	
BL-1720	16.5-20.1	42.0	44.5	25.4	1.6	12.7	
BL-2225	22.2-25.4	42.0	44.5	25.4	1.6	12.7	

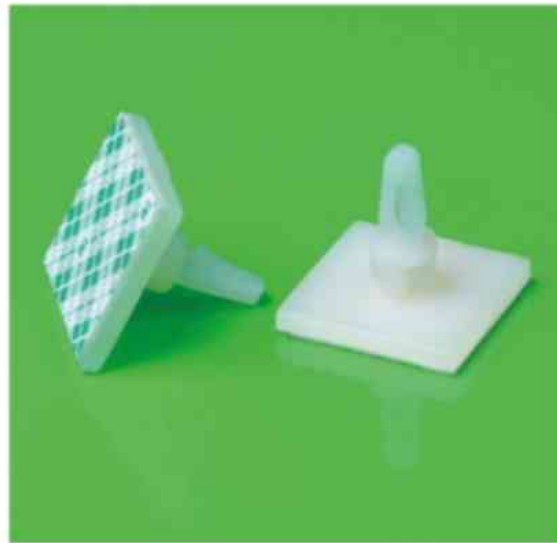

插柄式固定座 Push Tie Mount

- ◆ 材质: UL合格之NYLON 66(灰色), 防火等级94V-2。
- ◆ 特点: 装配简单、快速、牢固, 开启容易, 可多次重复使用。
- ◆ 用法: 放基板钻孔6.4mm, 将插柄式固定座插入固定放基板上, 最后将电线置放圆孔中, 轻轻一扣即可完成配线工作, 可松开重复使用。
- ◆ Material: UL qualified NYLON 66 (gray), fire and other extreme 94V-2.
- ◆ Features: Assembly is simple, fast, strong, open easily, can be used repeatedly.
- ◆ Usage: put the board drilling 6.4mm, will be put into the fixing bolt anchor on board, most Jun wires placed in the hole, light a buckle button to complete the wiring work, loosen the repeated use.

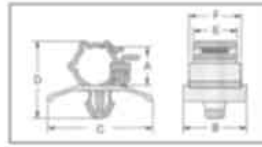

规格 ITEM.NO.	A(mm)	B(mm)	C(mm)	D(mm)	E(mm)	F(mm)	包装 PACKING
BL-10	10.1	17.2	28.4	20.7	11.9	14.3	100pcs
BL-15	14.9	19.3	31.8	27.1	14.0	16.3	
BL-18	17.3	21.2	35.0	29.8	15.9	18.3	



超博LED间隔柱 Super Bo LED Spacers

- ◆ 材质: UL合格之NYLON 66, 防护等级94V-2。
- ◆ 颜色: NATURAL尼龙本色。
- ◆ 用途: 保护3mm或5mmLED立于PC板上, 接脚不会弯曲, 折断, 且使LED高度一致, 免用治具, 尺寸齐全, 不占空间。
- ◆ Material: UL qualified NYLON66, protection class 94V-2.
- ◆ Color: NATURAL nylon qualities.
- ◆ Purpose: Protect 3mm or 5mmLED stand PC board, pin will not bend, break, and the LED highly consistent with the rule of free, full size, not the space.

规格 ITEM.NO.	外径 A(mm)	孔最大距 B(mm)	高度 L(mm)	包装 PACKING
BLD4-1.0	4.0	3.3	1.0	10000pcs
BLD4.5-1.2	4.5	3.3	1.2	



方孔LED间隔柱 Square Hole LED Spacers

- ◆ 材质: UL合格之NYLON 66, 防护等级94V-2。
- ◆ 颜色: NATURAL尼龙本色。
- ◆ 用途: 保护3mm或5mmLED立于PC板上, 接脚不会弯曲, 折断, 且使LED高度一致, 免用治具, 尺寸齐全, 不占空间, 装配快捷美观。
- ◆ 特点: 高度L从1.5-24mm, 每间隔为0.5mm; 两孔方形结构。
- ◆ Material: UL qualified NYLON 66, protection class 94V-2.
- ◆ Color: NATURAL nylon qualities.
- ◆ Uses: Protection 3mm or 5mmLED stand PC board, pin will not bend, break, and the LED highly consistent with the rule of free, full size, space, assembly fast and beautiful.
- ◆ Features: Highly L from 1.5-24mm, each interval is 0.5mm; two holes square structure.

规格 ITEM.NO.	φA(mm)	φB(mm)	C(mm)	L(mm)	包装 PACKING
BLD4-L	4.0	2.8	1.0	1.5-24	5000pcs
BLD4.5-L	4.5	3.2	1.0	1.5-24	
BLD5-L	5.0	3.2	1.0	1.5-24	
BLD7-L	7.0	5.0	1.0	3-20	
BLD9-L	9.0	5.0	1.0	3-20	



圆孔LED间隔柱 Round Hole LED Spacers

- ◆ 材质: UL合格之NYLON 66, 防护等级94V-2。
- ◆ 颜色: NATURAL尼龙本色。
- ◆ 用途: 保护3mm或5mmLED立于PC板上, 接脚不会弯曲, 折断, 且使LED高度一致, 免用治具, 尺寸齐全, 不占空间, 装配快捷美观。
- ◆ 特点: 高度L从1.5-24mm, 每间隔为0.5mm; 两孔方形结构。
- ◆ Material: UL qualified NYLON 66, protection class 94V-2.
- ◆ Color: NATURAL nylon qualities.
- ◆ Uses: Protection 3mm or 5mmLED stand PC board, pin will not bend, break, and the LED highly consistent with the rule of free, full size, space, assembly fast and beautiful.
- ◆ Features: Highly L from 1.5-24mm, each interval is 0.5mm; two holes square structure.

规格 ITEM.NO.	φA(mm)	φB(mm)	φC(mm)	D(mm)	L(mm)	包装 PACKING
BLD4A-L	4.0	2.8	1.0	2.54	1.5-24	5000pcs
BLD5A-L	5.0	3.2	1.0	2.54	1.5-24	

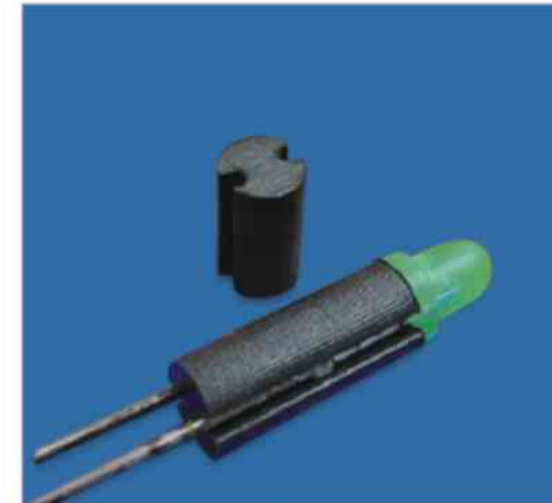

圆孔双坑LED间隔柱 The Hole Double Pit LED Spacers

- ◆ 材质: UL合格之NYLON 66, 防护等级94V-2。
- ◆ 颜色: NATURAL尼龙黑色/本色。
- ◆ 用途: 保护3mm或5mmLED立于PC板上, 接脚不会弯曲, 折断, 且使LED高度一致, 免用治具, 尺寸齐全, 不占空间, 装配省时美观。
- ◆ 特点: 圆孔结构, 松紧适度, 高度L每间隔为0.5mm。
- ◆ Material: UL qualified NYLON 66, protection class 94V-2.
- ◆ Color: NATURAL nylon black / gray.
- ◆ Uses: Protection 3mm or 5mmLED stand PC board, pin will not bend, break, and the LED highly consistent with the rule of free, full size, space, beautiful province assembly.
- ◆ Features: hole structure, elastic moderate. Height L per interval is 0.5mm.

规格 ITEM.NO.	φA(mm)	φB(mm)	φC(mm)	D(mm)	L(mm)	包装 PACKING
BLD4A-L	4.0	2.8	1.0	2.54	1.5-24	5000pcs
BLD5A-L	5.0	3.2	1.0	2.54	1.5-24	



PC板固定座 PC Board Holder

- ◆ 材质: UL合格之NYLON66(本色), 防火等级94V-2
- ◆ 颜色: 尼龙本色。
- ◆ 用途: 快速固定PC板, 外观美丽。
- ◆ 特点: 无需工具, 即可固定PC板; 一端直接粘到基板上, 免去钻孔的麻烦。
- ◆ Material: UL qualified NYLON66 (character), fire rating 94V-2
- ◆ Color: nylon color.
- ◆ Uses: Quick fixed PC board, look beautiful.
- ◆ Features: No tools, can be fixed PC board; one end directly attached to the substrate, eliminating troublesome drilling.

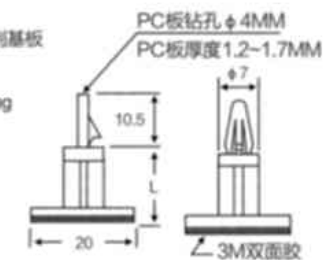

规格 SIZE(MM)	L(mm)	包装 PACKING	规格 SIZE(MM)	L(mm)	包装 PACKING
BL-6	6.0	500pcs	BL-12	12.0	500pcs
BL-8	8.0	500pcs	BL-16	16.0	500pcs
BL-10	10.0	500pcs	BL-19	19.0	500pcs
BL-11	11.0	500pcs	BL-22	22.0	500pcs



PC板间隔柱 PC Board Spacers

- ◆ 材质: UL合格之NYLON66, 防护等级94V-2。
- ◆ 颜色: 尼龙本色。
- ◆ 用途: 支撑PC板, 使中间不至震动、载重而凹陷短路。
- ◆ 特点: 先将基板钻孔 $\phi 3\text{mm}$, 再将隔离柱由底面往上推入固定后, 再把PC板固定即可。
- ◆ Material: UL qualified NYLON66, protection class 94V-2.
- ◆ Color: nylon color.
- ◆ Purpose: to support the PC board, the intermediate is not to shock, load and short circuit depression.
- ◆ Features: First base drilling $\phi 3\text{mm}$, then isolated after column pushed up from the bottom surface of the fixed, then the PC board can be fixed.

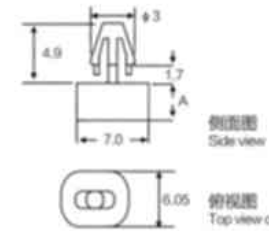

规格 ITEM.NO.	A(mm)	包装 PACKING
BL-2.2	2.2	2000pcs
BL-2.5	2.5	
BL-3.5	3.5	
BL-4.5	4.5	
BL-5.5	5.5	



月牙间隔柱 Crescent Spacers

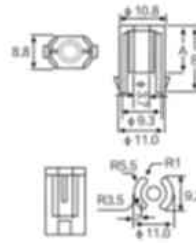

- ◆ 材质: ABS材质。
- ◆ 颜色: ABS本色/黑色。
- ◆ 用途: 一般用于DVD内部之PC板固定。
- ◆ 特点: 使用方便。
- ◆ Material: ABS material.
- ◆ Color: ABS Natural / black.
- ◆ Uses: generally used for DVD inside the PC board is fixed.
- ◆ Features: Easy to use.

规格 ITEM.NO.	A(mm)	B(mm)	包装 PACKING
BL-5	5.0	10.5	1000pcs
BL-7.5	7.5	12.0	
BL-8	8.0	12.5	
BL-12	12.0	16.5	



PC板间隔柱 PC Board Spacers

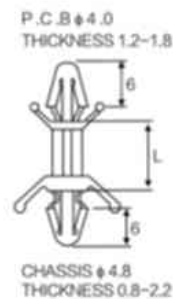

- ◆ 材质: UL合格之NYLON66, 防护等级94V-2。
- ◆ 颜色: 尼龙本色。
- ◆ 用途: 先将基板钻孔 $\phi 4\text{mm}$ 或 $\phi 4.8\text{mm}$, 将隔离柱固定, 再把PC板固定即可。
- ◆ 特点: 一头适用 $\phi 4\text{mm}$ 的钻孔, 一头适用 $\phi 4.8\text{mm}$ 的钻孔。
- ◆ Material: UL qualified NYLON66, protection class 94V-2.
- ◆ Color: Nylon character.
- ◆ Uses: First base drilling $\phi 4\text{mm}$ or $\phi 4.8\text{mm}$, the spacers fixed, then the PC board can be fixed.
- ◆ Features: a head applies a head applicable $\phi 4.8\text{mm}$ $\phi 4\text{mm}$ drilling boreholes.

规格 ITEM.NO.	L(mm)	包装 PACKING	规格 ITEM.NO.	L(mm)	包装 PACKING
BL212-05	4.75	1000pcs	BL212-16	16.0	1000pcs
BL212-06	6.35		BL212-19	19.0	
BL212-10	9.55		BL212-22	22.2	
BL212-13	12.7		BL212-25	25.0	



十字盘头螺丝 Phillips Pan Head Screws

- ◆ 材质: UL合格之NYLON66或PC。
- ◆ 颜色: 本色或黑色。
- ◆ 用途: PC板、机板及其他器具固定用, 具有防生锈、防腐蚀的优点。

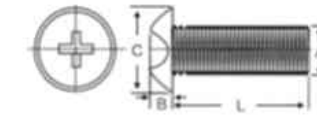

- ◆ Material: UL qualified NYLON66 or PC.
- ◆ Color: Natural or black.
- ◆ Uses: PC board, board, and other equipment fixing, with anti-rust, anti-corrosion attack.

规格 ITEM.NO.	A (mm)	长度 Length L (mm)	B (mm)	C (mm)	PITCH (mm)	包装 PACKING
BLF2-L	M2	5, 6, 8, 10	1.35	3.5	0.4	1000pcs
BLF2.5-L	M2.5	5, 6, 8, 10, 12	2.0	4.3	0.45	
BLF3-L	M3	6, 8, 10, 12, 14, 16, 18, 20, 25, 30	1.65	5.5	0.5	
BLF4-L	M4	6, 8, 10, 12, 14, 16, 18, 20, 25, 30	2.7	6.5	0.7	
BLF5-L	M5	8, 10, 12, 15, 20, 22, 25, 30, 40	2.7	9.3	0.8	100pcs
BLF6-L	M6	10, 12, 15, 20, 22, 25, 30, 40	3.3	11.3	1.0	
BLF8-L	M8	12, 15, 20, 22, 25, 30, 40	4.65	15.8	1.25	



十字沉头螺丝 Phillips Head Screws

- ◆ 材质: UL合格之NYLON66或PC。
- ◆ 颜色: 本色或黑色。
- ◆ 用途: PC板、机板及其他器具固定用, 沉头设计, 固定后螺丝头不会突出表面, 塑胶材质具有防生锈、防腐蚀, 重量轻的优点。

- ◆ Material: UL qualified NYLON66 or PC.
- ◆ Color: Natural or black.
- ◆ Uses: PC board, board, and other equipment fixing, countersunk head design, after fixing the screw head does not protrude surface, plastic material with anti-rust, corrosion, light weight advantages.

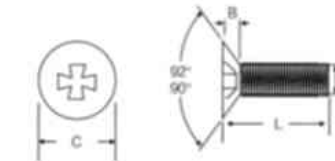

规格 ITEM.NO.	A (mm)	长度 Length L (mm)	B (mm)	C (mm)	PITCH (mm)	包装 PACKING
BLT3-L	M3	6, 8, 10, 12, 14, 16, 18, 20, 25, 30	1.65	5.5	0.5	1000pcs
BLT4-L	M4	6, 8, 10, 12, 14, 16, 18, 20, 25, 30	2.7	6.5	0.7	
BLT5-L	M5	8, 10, 12, 15, 20, 22, 25, 30, 40	2.7	9.3	0.8	100pcs
BLT6-L	M6	10, 12, 15, 20, 22, 25, 30, 40	3.3	11.3	1.0	
BLT8-L	M8	12, 15, 20, 22, 25, 30, 40	4.65	15.8	1.25	

Hexagon Screws/Metric plastic nut



外六角螺丝 Hexagon Screws

- ◆ 材质: UL合格之NYLON66或PC。
- ◆ 颜色: 本色或黑色。
- ◆ 用途: PC板、机板及其他器具固定用, 塑胶材质具有防生锈, 防腐蚀, 重量轻的优点。
- ◆ 备注: 订购时请注明PC。一般情况是尼龙材质。
- ◆ Material: UL qualified NYLON66 or PC.
- ◆ Color: Natural or black.
- ◆ Uses: PC board, board, and other equipment for fixing plastic material with anti-rust, corrosion, light weight advantages.
- ◆ Note: Please specify when ordering PC. General situation is nylon.

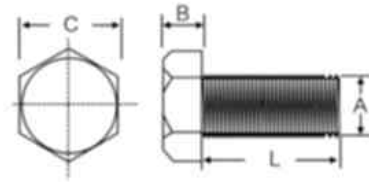

规格 ITEM.NO.	A (mm)	长度 Length L (mm)	B (mm)	C (mm)	PITCH (mm)	包装 PACKING
BL4-L	M4	6,8,10,12,14,16,18,20,25,30	2.7	6.5	0.7	1000pcs
BL5-L	M5	8,10,12,15,20,22,25,30,40	2.7	9.3	0.8	
BL6-L	M6	10,12,15,20,22,25,30,40	3.3	11.3	1.0	
BL8-L	M8	12,15,20,22,25,30,40	4.65	15.8	1.25	100pcs
BL10-L	M10	15,20,22,25,30,40,50,60,70	6.4	16	1.5	
BL12-L	M12	15,20,22,25,30,40,50,60,70	7.5	18	1.75	

公制塑胶螺母 Metric Plastic Nut

- ◆ 材质: UL合格之NYLON66或PC
- ◆ 用途: PC板, 基板固定作用。
- ◆ 特点: 绝缘性佳, 不生锈, 不腐蚀, 重量轻。
- ◆ Material: UL qualified NYLON66 or PC
- ◆ Uses: PC board, the substrate immobilization.
- ◆ Features: good insulation, no rust, no corrosion, and light weight.

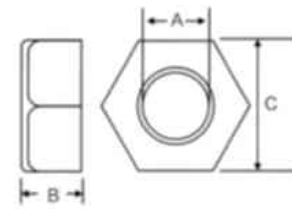

规格 ITEM.NO.	A (mm)	B (mm)	C (mm)	PITCH (mm)	包装 PACKING
BLN2	M2	1.2	3.9	0.4	1000pcs
BLN3	M3	2.5	5.6	0.5	
BLM3	M3	2.5	6.3	0.5	
BLN4	M4	3.4	7.0	0.7	
BLN5	M5	4.0	8.0	0.8	
BLN6	M6	5.0	10.0	1.0	100pcs
BLN8	M8	6.5	12.0	1.25	
BLN10	M10	8.4	16.0	1.5	
BLN12	M12	10.8	18.0	1.75	

Heat Shrinkable Tubings



热收缩套管 Heat Shrinkable Tubings

- 功能: Function:
1. 电线之保护与绝缘。 1. wire coat and insulation.
 2. 端子与电线接头之绝缘与保护。 2. make the joint of terminal block and wire insulated.
 3. 分色作用。 3. divide the colors.
 4. 防水。 4. water-proof.
 5. 电阻电容器之保护与绝缘。 5. protection and insulation of resistors and electrical capacitors.
- Standard color: black, white, red, blue, yellow, green, brown, grey, orange and purple.

规格 ITEM.NO.	收缩前 AS SUPPLIED 内径 I.D (mm)	收缩前 AS SUPPLIED 厚度 (mm)	收缩前 AS SUPPLIED 内径 I.D (mm)	收缩前 AS SUPPLIED 厚度 (mm)	包装 PACKING (M/ROLL)
BLS-1	1.0	0.2 ± 0.05	0.5	0.4 ± 0.05	400pcs
BLS-1.5	1.5	0.2 ± 0.05	0.75	0.4 ± 0.05	300pcs
BLS-2	2.0	0.25 ± 0.05	1.0	0.45 ± 0.1	200pcs
BLS-2.5	2.5	0.25 ± 0.05	1.25	0.45 ± 0.1	
BLS-3	3.0	0.25 ± 0.05	1.5	0.45 ± 0.1	
BLS-3.5	3.5	0.25 ± 0.05	1.75	0.45 ± 0.1	100pcs
BLS-4	4.0	0.25 ± 0.05	2.0	0.45 ± 0.1	
BLS-5	5.0	0.35 ± 0.05	2.5	0.55 ± 0.1	
BLS-6	6.0	0.35 ± 0.05	3.0	0.55 ± 0.1	
BLS-7	7.0	0.35 ± 0.05	3.5	0.55 ± 0.1	
BLS-8	8.0	0.35 ± 0.05	4.0	0.55 ± 0.1	
BLS-9	9.0	0.35 ± 0.05	4.5	0.55 ± 0.1	
BLS-10	10.0	0.35 ± 0.05	5.0	0.60 ± 0.1	
BLS-11	11.0	0.35 ± 0.05	5.5	0.60 ± 0.1	
BLS-12	12.0	0.35 ± 0.1	6.0	0.70 ± 0.1	
BLS-13	13.0	0.35 ± 0.1	6.5	0.70 ± 0.1	50pcs
BLS-14	14.0	0.35 ± 0.1	7.0	0.70 ± 0.1	
BLS-15	15.0	0.35 ± 0.1	7.5	0.70 ± 0.1	
BLS-16	16.0	0.35 ± 0.1	8.0	0.70 ± 0.1	
BLS-18	18.0	0.4 ± 0.1	9.0	0.80 ± 0.1	
BLS-20	20.0	0.5 ± 0.1	10.0	0.90 ± 0.1	



铁氟龙套管 Teflon Tube

铁氟龙套管为塑胶中耐温最高(-65℃~+280℃)耐电压(45KV/mm)耐强酸、强碱、抗粘、滑溜、耐磨之工程塑胶材料，被广泛用于机械、汽车、电子、化工、阀门等零件。

铁氟龙套管，聚四氟乙烯(P.T.F.E)广泛用于化学、仪器、电热、机械工业；其中绝缘套管由于耐温、耐电压(300V/600V)而广泛用于航天、汽车、医疗、电子变压器、通讯等科技工业。

Teflon casing for the plastic resistance in the maximum temperature (-65℃~+280℃) high voltage (45KV/mm) resistance to acid, alkali, anti slippery, wear-resisting, engineering plastic materials, which are widely used in machinery, automobile, electronics, chemicals, valves and other components.

Teflon tube, Teflon (P.T.F.E) are widely used in chemical, instrument, electric, machinery industry; wherein the insulating casing due to high temperature, high voltage (300V/600V) and widely used in aerospace, automotive, medical, electronic transformers, communications and other science and technology industry.

铁氟龙之性能指标 Teflon Characteristics

- ◆ 比例: 2.1~2.3kg/cm
- ◆ 击穿强度: 16.4mg/1000 Circle
- ◆ 摩擦系数: 0kg/1000 Circle
- ◆ Ratio: 2.1~2.3kg/cm
- ◆ Breakdown strength: 16.4mg/1000 Circle
- ◆ 摩擦系数: 0kg/1000 Circle
- ◆ 击穿强度: 45KV/mm
- ◆ 摩擦系数: 0kg/1000 Circle
- ◆ 抗拉强度: 280~352kg/cm
- ◆ 熔点: 317~327℃
- ◆ 伸长率: 200~400%
- ◆ 热变形温度: 260℃
- ◆ 耐电弧性: <300 second
- ◆ 有机溶剂影响: 耐性非常强
- ◆ 吸水率: 0.1
- ◆ 耐酸强度: 耐性非常强
- ◆ Ratio: 2.1~2.3kg/cm
- ◆ Breakdown: 45KV/mm
- ◆ Tensile Strength: 280~352kg/cm
- ◆ Elongation: 200~400%
- ◆ Arc-Resist: <300 second
- ◆ Water absorption: 0.1
- ◆ Breakdown strength: 16.4mg/1000 Circle
- ◆ Friction coefficient: 0kg/1000 Circle
- ◆ Melting point: 317~327℃
- ◆ Temperature of thermal deformation: 260℃
- ◆ Influence of Organic Solvents: patience is very strong
- ◆ Weak acid strength: patience is very strong

规格 ITEM.NO.	铁氟龙绝缘套管 TEFLON INSULATE COVER TUBE						铁氟龙套管 TEFLON TUBE					
	内径 ID (mm)			外径 OD (mm)			内径 ID (mm)	外径 OD (mm)	内径 ID (mm)	外径 OD (mm)	内径 ID (mm)	外径 OD (mm)
	最小 LEAST	正常 NORMAL	最大 MAX	S型 S-TYPE	T型 T-TYPE	L型 L-TYPE						
BL-30	0.25	0.30	0.38	0.76	0.76	0.60	0.5	1.5	5.0	7.0	9.0	10.0
BL-28	0.33	0.38	0.46	0.84	0.84	0.68	1.0	2.0	5.0	8.0	9.0	10.5
BL-26	0.41	0.46	0.53	0.92	0.92	0.76	1.0	3.0	5.0	9.0	9.0	11.0
BL-24	0.51	0.56	0.66	1.16	1.06	0.86	1.5	2.5	5.5	6.5	9.0	12.0
BL-23	0.58	0.66	0.74	1.26	1.16	0.96	1.6	2.52	5.5	7.5	9.5	10.5
BL-22	0.66	0.71	0.81	1.31	1.21	1.01	2.0	3.0	6.0	7.0	9.5	11.5
BL-21	0.74	0.81	0.89	1.41	1.31	1.11	2.0	4.0	6.0	7.5	3/8"	7/16"
BL-20	0.81	0.86	0.97	1.66	1.46	1.16	2.0	4.5	6.0	8.0	10.0	11.0
BL-19	0.91	0.96	1.07	1.76	1.56	1.26	2.0	5.0	6.0	9.0	10.0	11.5
BL-18	1.01	1.07	1.17	1.87	1.67	1.37	2.2	5.4	6.0	10.0	10.0	12.0
BL-17	1.14	1.19	1.32	1.99	1.79	1.49	3/32"	5/32"	1/4"	5/16"	10.0	13.0
BL-16	1.29	1.4	1.47	2.14	1.94	1.64	2.5	3.5	6.5	7.5	11.0	12.0
BL-15	1.45	1.50	1.53	2.30	2.10	1.80	2.5	4.5	6.5	8.0	11.0	12.5
BL-14	1.62	1.68	1.65	2.48	2.28	2.08	3.0	4.0	6.5	8.5	11.0	13.0
BL-13	1.83	1.93	2.05	2.73	2.53	2.33	3.0	4.5	7.0	8.0	11.0	14.0
BL-12	1.95	2.16	2.31	2.96	2.76	2.56	3.0	5.0	7.0	8.5	7/16"	1/2"
BL-11	2.31	2.41	2.57	3.21	3.01	2.81	3.0	6.0	7.0	9.0	11.4	12.9
BL-10	2.59	2.69	2.84	3.49	3.29	3.09	1/8"	3/16"	7.0	10.0	12.0	13.0
BL-9	2.90	3.00	3.15	4.00	3.76	3.40	3.5	4.5	7.5	8.5	12.0	14.0
BL-8	3.28	3.38	3.53	4.38	4.14	3.78	3.5	5.5	7.5	9.0	12.0	15.0
BL-7	3.65	3.76	3.94	4.76	4.52	4.16	4.0	5.0	7.5	9.5	1/2"	9/16"
BL-6	4.11	4.22	4.41	5.22	4.98	4.72	4.0	5.5	5/16"	3/8"	13.0	14.0
BL-5	4.62	4.72	4.95	5.73	5.48	5.22	4.0	6.0	8.0	9.0	13.0	15.0
BL-4	5.18	5.28	5.53	6.28	6.04	5.78	4.0	7.0	8.0	9.5	13.0	16.0
BL-3	5.81	5.91	6.20	6.94	6.70	6.44	4.0	8.0	8.0	10.0	14.0	15.0
BL-2	6.55	6.68	6.93	7.68	7.44	7.18	3/16"	1/4"	8.0	11.0	14.0	16.0
BL-1	7.34	7.46	7.75	8.46	8.22	7.96	5.0	6.0	8.5	9.5	15.0	17.0
BL-0	8.26	8.38	8.69	9.38	9.14	8.88	5.0	6.5	8.5	10.5	15.0	18.0

硅橡胶玻璃纤维套管 Silicone Rubber Glassfiber Sleeving

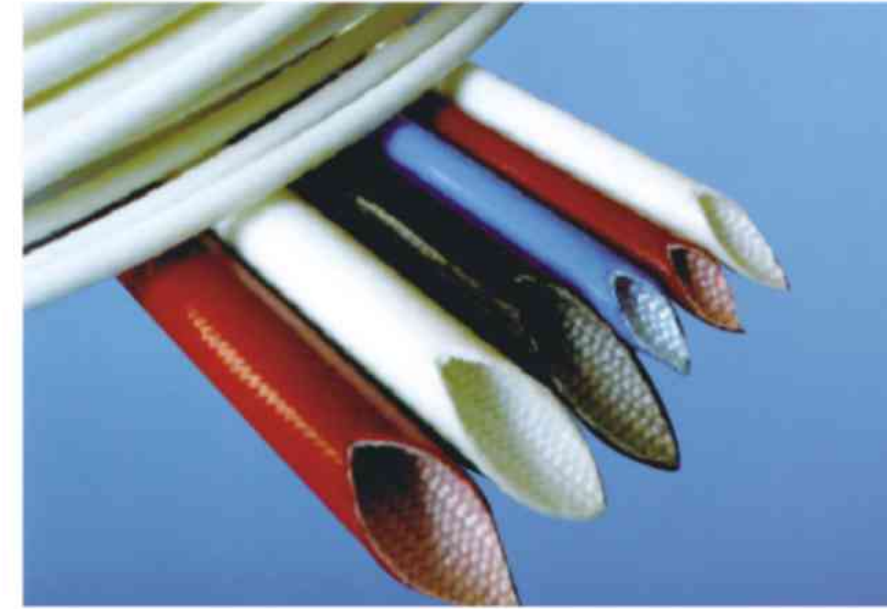

JYT-A硅橡胶玻璃纤维套管(亦称内纤外胶)是由无碱玻璃纤维编织成管状，涂覆液体有机硅橡胶，经高温处理而成，具有高介电强度，良好的柔软性、耐热老化性、阻燃性、耐温等级为200℃。广泛用于高要求的H级电机、家用电器、电热设备、电子器件及集束电缆等绝缘保护。

JYT-A silicone rubber fiberglass sleeving (also known as fiber inside and rubber outside) is woven into a tubular E-glass fiber, coated with the Baptist liquid silicone rubber, made by high temperature processing. With high dielectric strength, good flexibility, heat aging resistance, flame resistance, and temperature rating of 200℃. Class H motors are widely used in high demand, household appliances, electric equipment, electronic devices and cluster electrical wiring insulation protection.

型号和特性 Type and Property

规格 ITEM.NO.	击穿电压 Breakdown voltage(V)		体积电阻率 Volume resistivity (Ωcm)	耐温 Temperature resistance	阻燃性 Flame resistance
	平均值 Average	最低值 Minim			
BL-A	7000	5000	10 ¹¹	+200℃ -40℃	UL1441 VW-1

尺寸 Dimension

标准 Standard	内径 Internal Diameter		壁厚 Wall thickness (mm)
	公差 Tolerance		
0.5-2.5	+0.25 -0.00		0.38 ± 0.10
3.0-4.5	+0.30 -0.00		0.45 ± 0.10
5.0-6.0	+0.35 -0.00		0.50 ± 0.10
7.0-9.0	+0.40 -0.00		0.63 ± 0.10
10.0-12.0	+0.50 -0.00		0.65 ± 0.10

颜色: 白色或乳白色, 亦可按客户要求生产彩色套管。
Color: white or milky white, are available on request to the production of color casing.

挤出型内纤外胶 Extrusion type fiber inside and rubber outside



硅橡胶玻璃纤维套管(亦称内纤外胶套管)系以无碱玻璃纤维编织成管状后在套管外层挤出机挤一层硅橡胶,并加热固化而成。比传统涂覆型的内纤外胶耐电压性更加稳定。由于硅橡胶具有极佳的耐热性和介电性能,故挤出型硅橡胶玻璃纤维套管被广泛应用于发热较高的电器高压绝缘保护。

Silicone rubber fiberglass sleeving (also known as fiber inside and outside the plastic casing) is E-glass fiber woven into a tubular casing outer layer of the extrusion machine extrusion layer of silicone rubber, and heat curing is made. Resistance voltage is more stable than traditional coated-fiber inside and rubber outside. Because the silicone rubber with excellent heat resistance and dielectric properties, extruded silicone rubber fiberglass sleeving has been widely used in high fever, high voltage electrical insulation protection.

型号和特性 Type and Property

规格 ITEM.NO.	绝缘破坏电压 Dielectric breakdown voltage		温度指数 Temperature index	防火等级 Fire rating
	平均值 Average	最低值 Minim		
BL-AG	7000V	5000V	+200°C	UL VW-1

尺寸 Dimension

规格 Specification	内径允许公差 Inside diameter tolerances (mm)	最小壁厚 Minimum wall thickness (mm)
φ0.8-φ2.5	+0.20 -0.00	0.40
φ3.0-φ4.5	+0.30 -0.00	0.45
φ5.0-φ7.0	+0.40 -0.00	0.50
φ8.0-φ10.0	+0.50 -0.00	0.65
φ12.0-φ20.0	+0.50 -0.00	0.70

注:外观通常为乳白色,亦可按客户要求加工成其它颜色,包装长度规格可分为30mRL、50mRL、100mRL壁厚可根据要求生产。
Note: The appearance is usually white, can also be processed into other colors according to customer requirements, packaging length according to the specifications can be divided into 30mRL, 50mRL, 100mRL, wall thickness can be produced on request.

玻璃纤维硅橡胶(内胶外纤)套管 Glassfiber Silicone Rubber Sleeving (inside is silicone rubber and outside is glassfiber)



JYT玻璃纤维硅橡胶套管(内胶外纤)系选用挤出生产的硅橡胶套管,外部编织玻璃纤维后,涂覆有机硅树脂经高温处理而成。具有很好的介电性能,良好的柔软性、阻燃性、耐温等级为200°C。广泛用于高要求的H级电机、家用电器、电热设备等绝缘保护。

JYT glass fiber silicone rubber casing (inside the plastic outer fiber) is selected out of the production of silicone rubber casing, external woven fiberglass coated with silicone resin by high temperature treatment from Has good dielectric properties, good flexibility, flame resistance, temperature rating is 200°C. Class H motors are widely used in high demand, household appliances, electric equipment, and other insulation to protect.

型号和特性 Type and Property

规格 ITEM.NO.	击穿电压 Breakdown voltage(V)		体积电阻率 Volume resistivity (Ωcm)	耐温 Temperature resistance	阻燃性 Flame resistance
	平均值 Average	最低值 Minim			
JYT	7000	5000	10 ¹¹	+200°C -40°C	UL1441 VW-1

尺寸 Dimension

内径 Internal Diameter		壁厚 Wall thickness (mm)	
标准 Standard	公差 Tolerance	硅橡胶管 Silicone rubber sleeving	玻璃纤维编织层 Glass fiber braided
1.0-2.5	+0.20 -0.00	0.40±0.50	0.20±0.30
3.0-4.5	+0.25 -0.00	0.50±0.60	0.20±0.30
5.0-6.0	+0.30 -0.00	0.60±0.70	0.25±0.35
7.0-8.0	+0.40 -0.00	0.70±0.80	0.30±0.40
9.0-10.0	+0.50 -0.00	0.80±0.90	0.35±0.45

颜色:白色,可按客户要求生产彩色套管。
Colour: white, Coloured sleeving can also be produced on customers requirements.

**BL-001**

- ◆ 旋转拉力强度调校用以调校拉力：1-3号适用于宽度2.5mm以下扎带，3-6号适用于3.6mm以下扎带，6-8适用于4.8mm以下扎带。
- ◆ 重量：0.32kg
- ◆ 长度：180mm
- ◆ 材质：金属
- ◆ Adjusting knob to correct number in window of handle: 1-3 for miniature cross section ties(2.5mm);3-6 for intermediate cross section ties(3.6mm);and 6-8 for standard cross section cable ties(4.8mm).
- ◆ Weight: 0.32 kg
- ◆ L: 180mm
- ◆ Material: Metal

**BL-600A**

- ◆ 适用于尼龙扎带宽度：2.4-4.8mm以下6.3"(160mm)
- ◆ 适用于快速捆扎电线电缆：自动切断扎带剩余部分并切二为一，可用的塑料扎带长50-350mm，宽4.8mm以下
- ◆ 重量：0.30kg
- ◆ 长度：165mm
- ◆ 材质：金属制
- ◆ Suitable for fast bind wire and cable automatic cut-and-bind left part Deviding cable tie 50-350mm, its width 4.8mm
- ◆ Weight: 0.30 kg
- ◆ L: 165mm
- ◆ Material: Metal

**BL-500**

- ◆ 适用于尼龙扎带宽度：2.4-4.8mm以下6.3"(160mm)
- ◆ 适用于快速捆扎电线电缆：自动切断扎带剩余部分并切二为一，可用的塑料扎带长50-350mm宽4.8mm以下
- ◆ 材质：塑胶制
- ◆ Suitable for fast bind wire and cable automatic cut-and-bind left part
- ◆ Deviding cable tie 50-350mm, its width 4.8mm
- ◆ Material: Plastic

全自动尼龙扎带机 Automatic Nylon Strapping Machine



适用范围 Scope of application

电子连接线、编织网管、套管、套管折弯再扎、电机线圈扎束带等
Electronic connecting line, braided sleeving, casing, casing bend and then tie, tie belt motor coil etc

技术参数 Technical parameters

机型 Model	HX60型/HX80型/HX100型/HX120型
电源电压 Power supply voltage	AC220V
电源频率 Power supply frequency	50/60HZ
额定功率 Rated power	100W
使用范围 Scope	60mm/80mm/100mm/120mm 束线带(Cable ties)
外型尺寸 Dimension	长(L)1230*宽(W)550*高(H)800(mm)
总重量 Total weight	150KG

特点说明 Features

1. 自动化PLC触摸屏控制电路，操作简单方便，工作稳定性好
 2. 散装尼龙扎带实现自动上料
 3. 自动穿锁扎带、自动剪断扎带，1800条/小时，省时省力，提高几倍工作效率。
 4. 扎带松紧触摸屏数字调节
 5. 扎带留尾触摸屏数字调节
 6. 没有气动
1. Automatic PLC control circuit for touch screen, simple operation, good stability
 2. Nylon strap automatic, bulk loading
 3. Strap, automatic, automatic wear locks cut strap 1800/hour, saving time and effort, several times raising work efficiency
 4. Tie elastic touch screen digital tuning
 5. Band-tail touch screen digital adjustment
 6. There is no air